

TO TIMER  
24286-01

(B)  
TO OTHER UPPER  
TRAY DRAWING

POWER IN  
23878-05

28011-01, REV A  
TRAY TOP  
548 SERIES '07

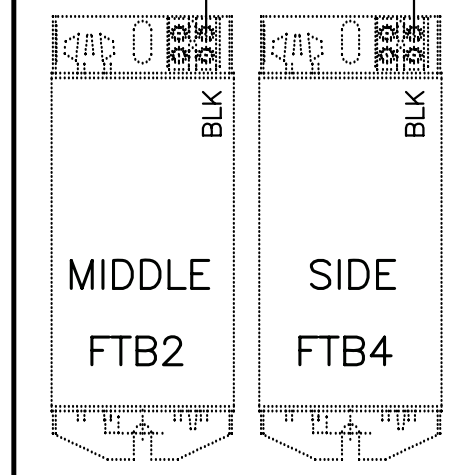
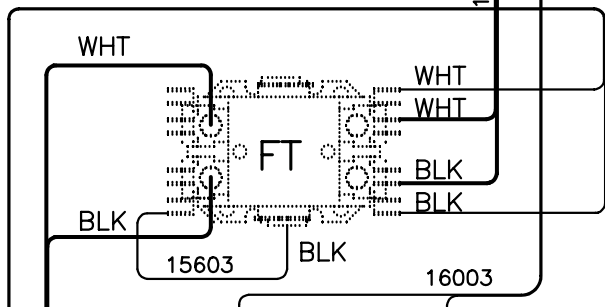
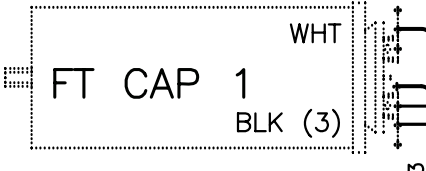
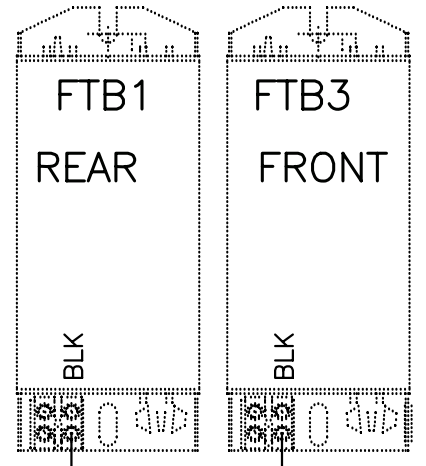
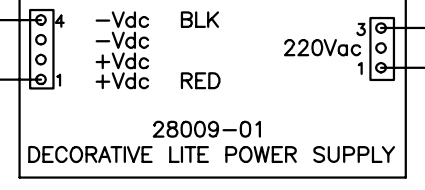
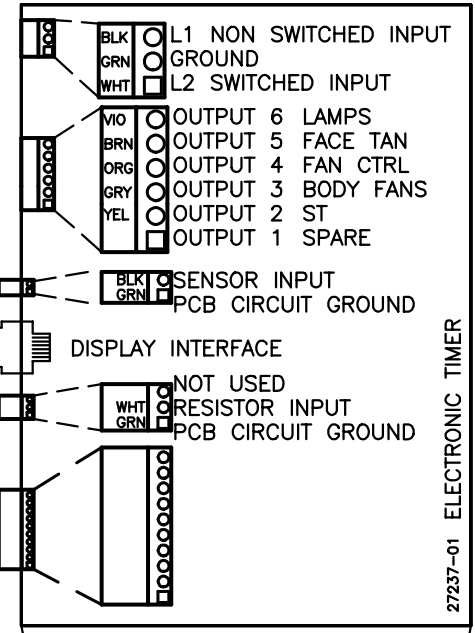

SHOULDER TANNER (ST) RELAY

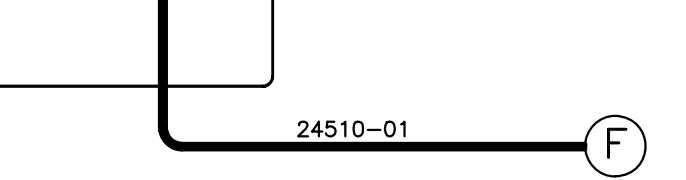
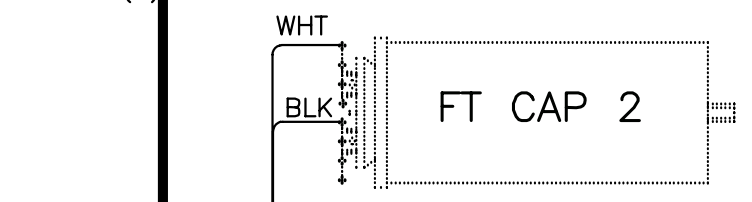
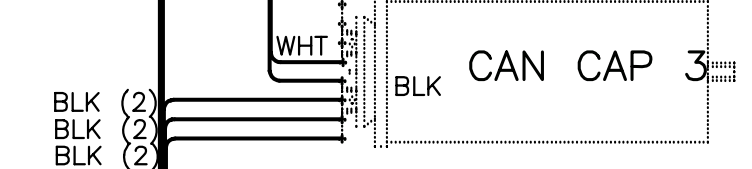
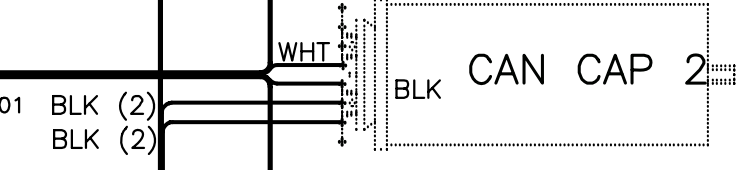
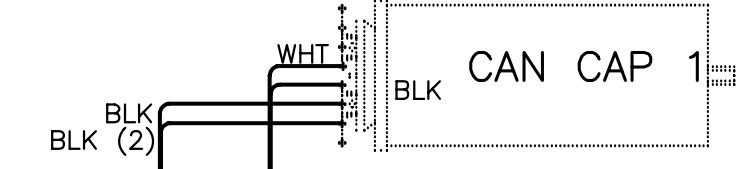
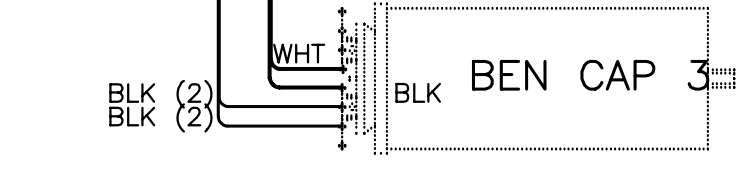
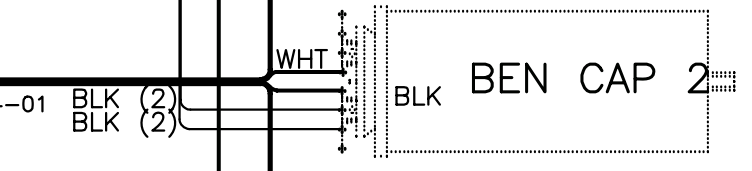
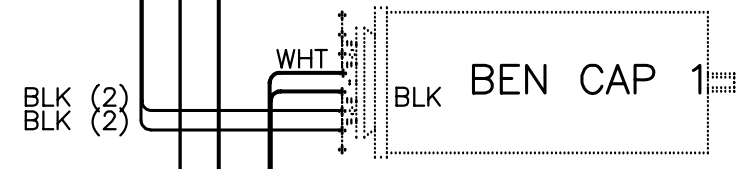
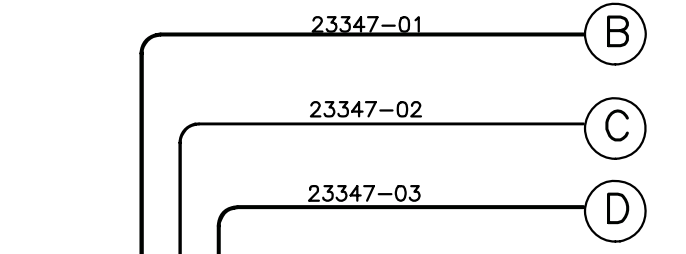
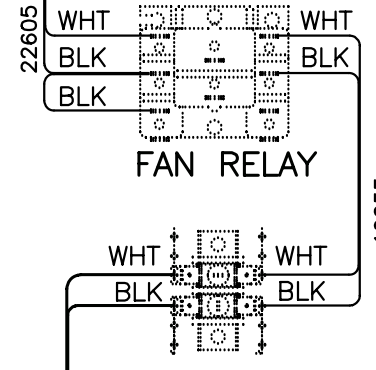
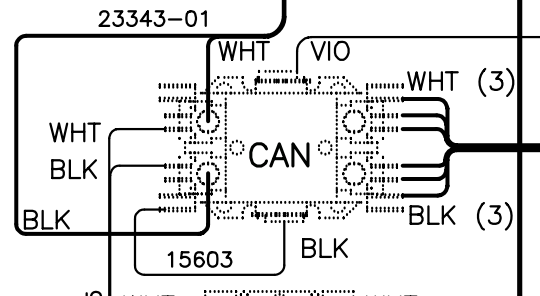
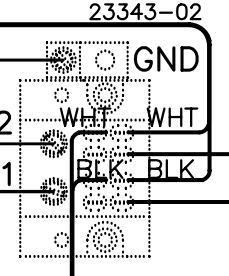
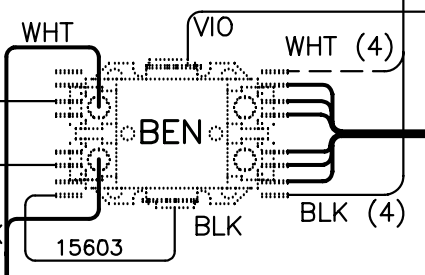
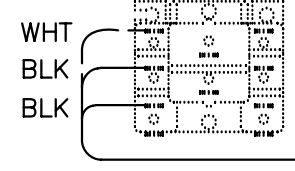

(F)

24486-03

27237-01 ELECTRONIC TIMER

27237-01 ELECTRONIC TIMER

ELECTRONIC TIMER

24488-03

27159-02

27239-01

27918-01

24489-01

16003

10573

15603

16003

24487-01

24105-04

22605

15603

23343-02

15607

23343-01

15603

22605

10255

23343-03

10873

24510-01

P2  
28005-01

P4  
23197-01

P5  
23199-01

TO BALLAST  
24 - 26

TO BALLAST 43 - 48

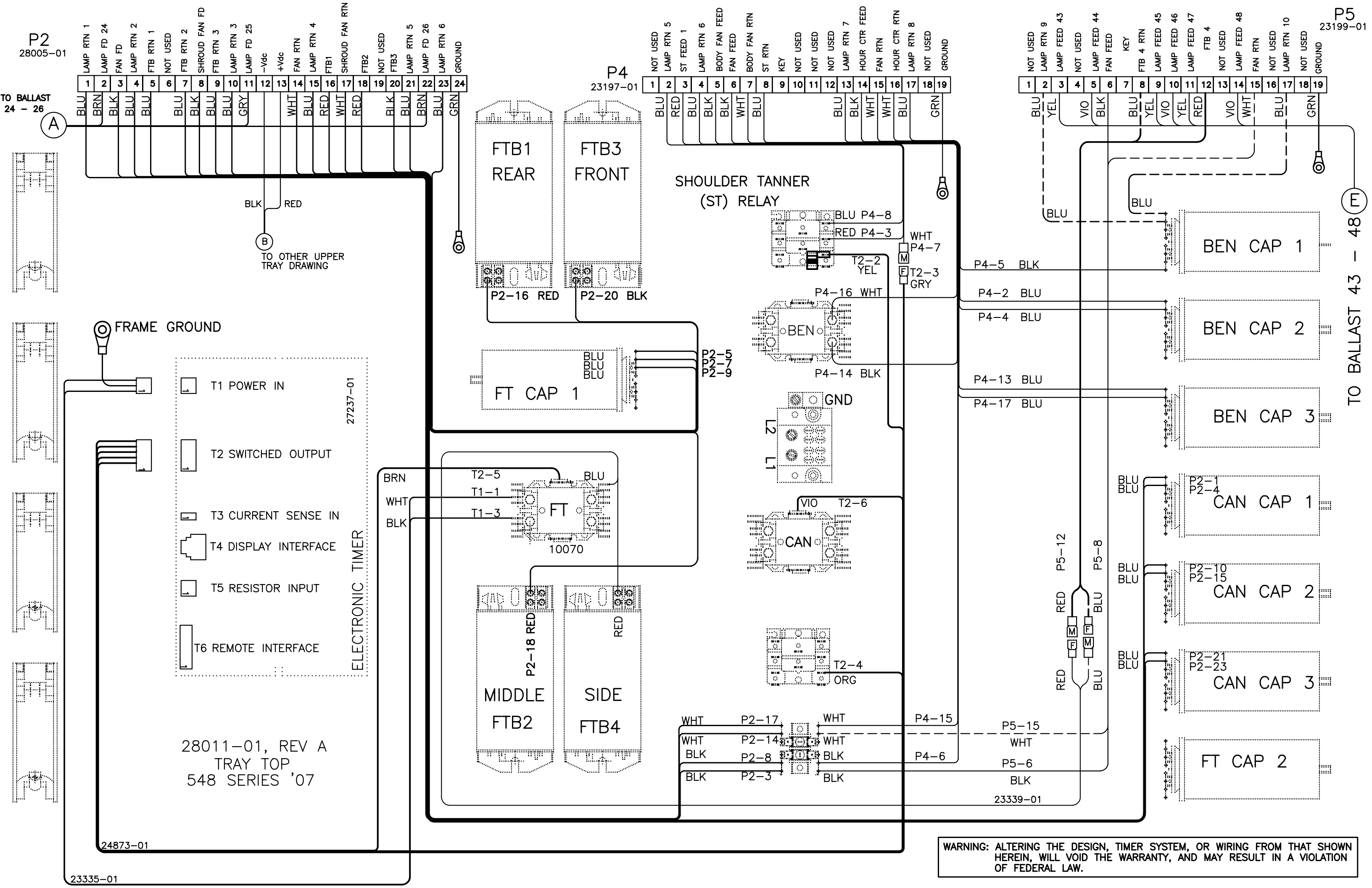

28011-01, REV A  
TRAY TOP  
548 SERIES '07

24873-01

23335-01

23339-01

WARNING: ALTERING THE DESIGN, TIMER SYSTEM, OR WIRING FROM THAT SHOWN HEREIN, WILL VOID THE WARRANTY, AND MAY RESULT IN A VIOLATION OF FEDERAL LAW.

P1  
23196-01

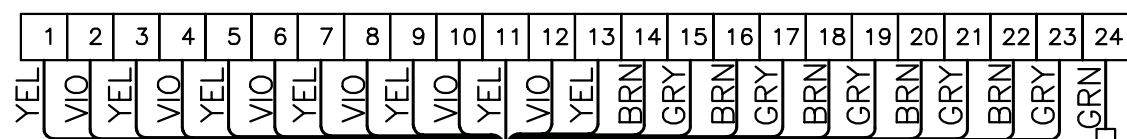

P3  
23195-01

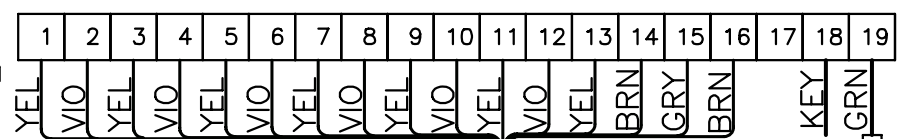

TO P2 (A) 24847-01

○ FRAME GROUND

○ FRAME GROUND

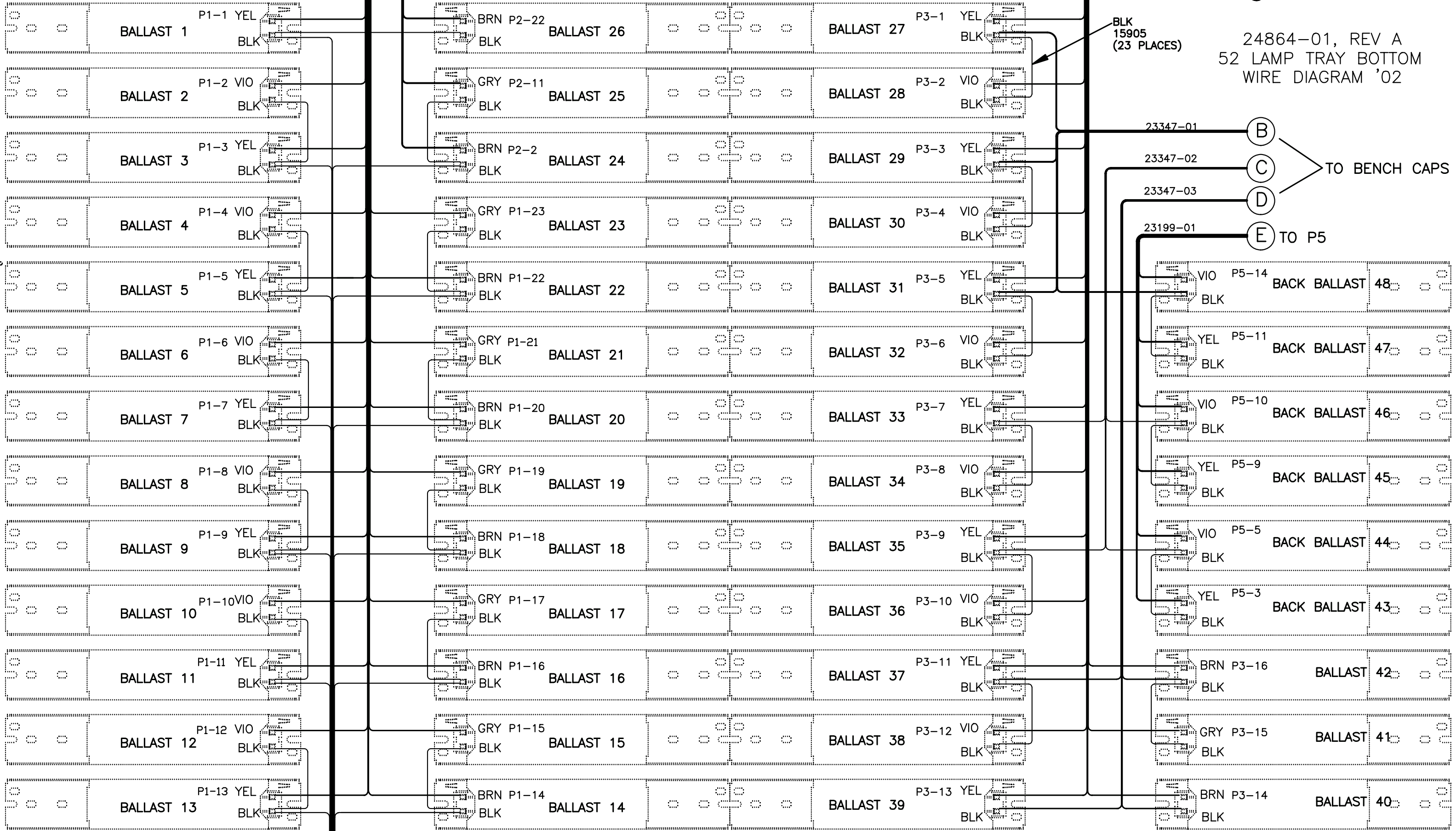

24864-01, REV A  
52 LAMP TRAY BOTTOM  
WIRE DIAGRAM '02

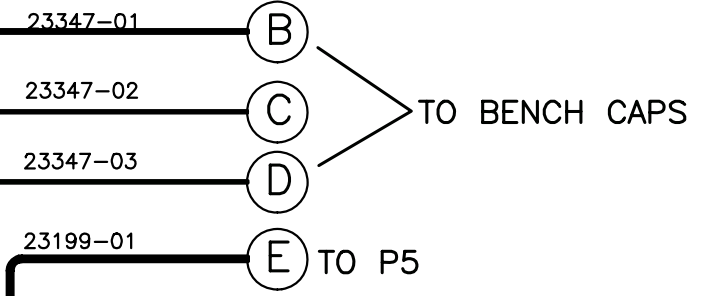

TO BENCH CAPS

TO P5

24510-01 (F) TO CANOPY CAPS

R3  
23348-01

1	2	3	4	5	6	7	8	9	10	11	12	13	14	15	16	17	18	19
YEL	VIO	YEL	VIO	YEL	VIO	YEL	VIO	YEL	VIO	YEL	VIO	YEL	VIO	YEL	VIO	GRN		

1	2	3	4	5	6	7	8	9	10	11	12	13	14	15	16	17	18	19
BLU	RED	BLU	BLK	BLK	WHT	BLU						BLU	BLK	WHT	WHT	BLU	GRN	
NOT USED	LAMP RTN	ST FEED	LAMP RTN	B FAN FEED	FAN FEED	B FAN RTN	ST RTN	KEY	NOT USED	NOT USED	NOT USED	LAMP RTN	H CTR FEED	FAN RTN	H CTR RTN	LAMP RTN	NOT USED	GROUND

R4  
24817-01

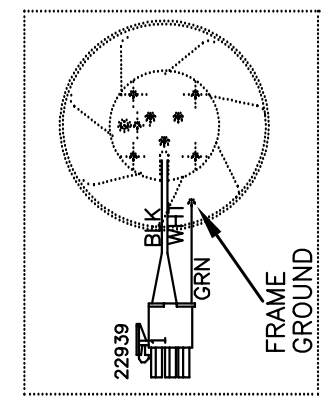
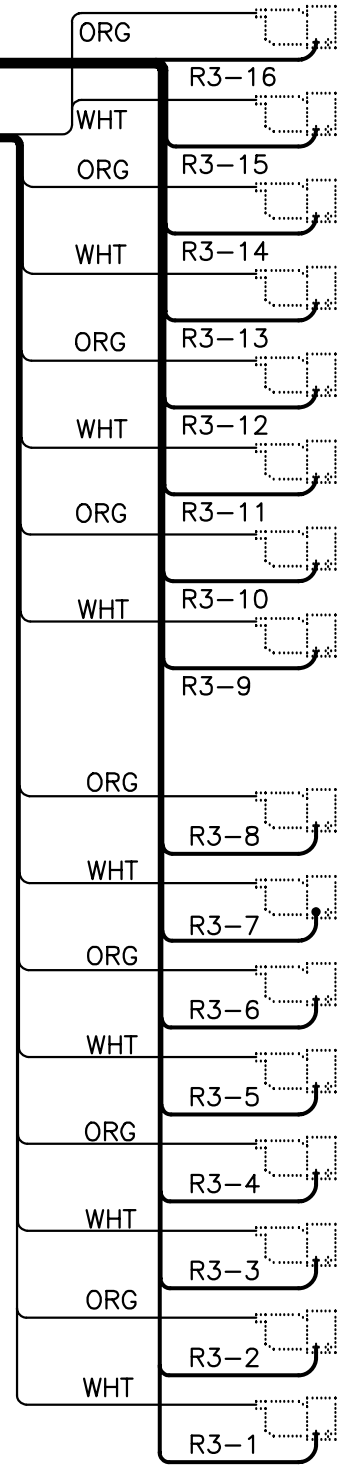
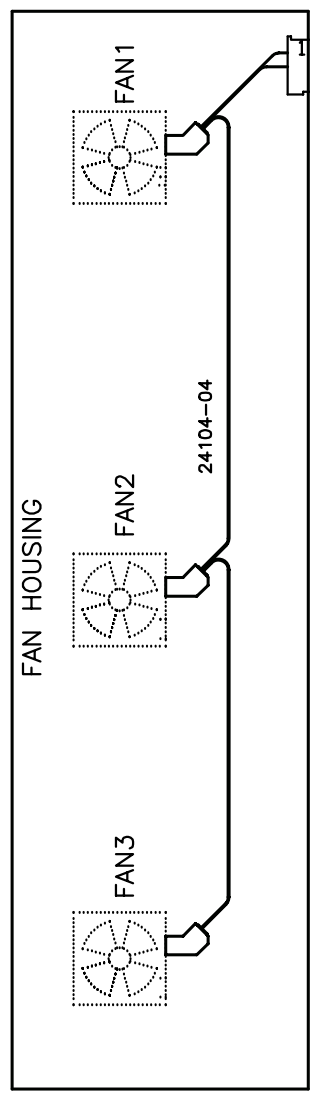
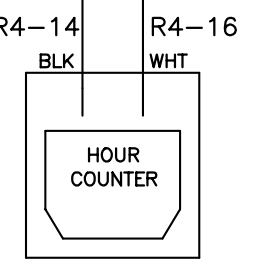
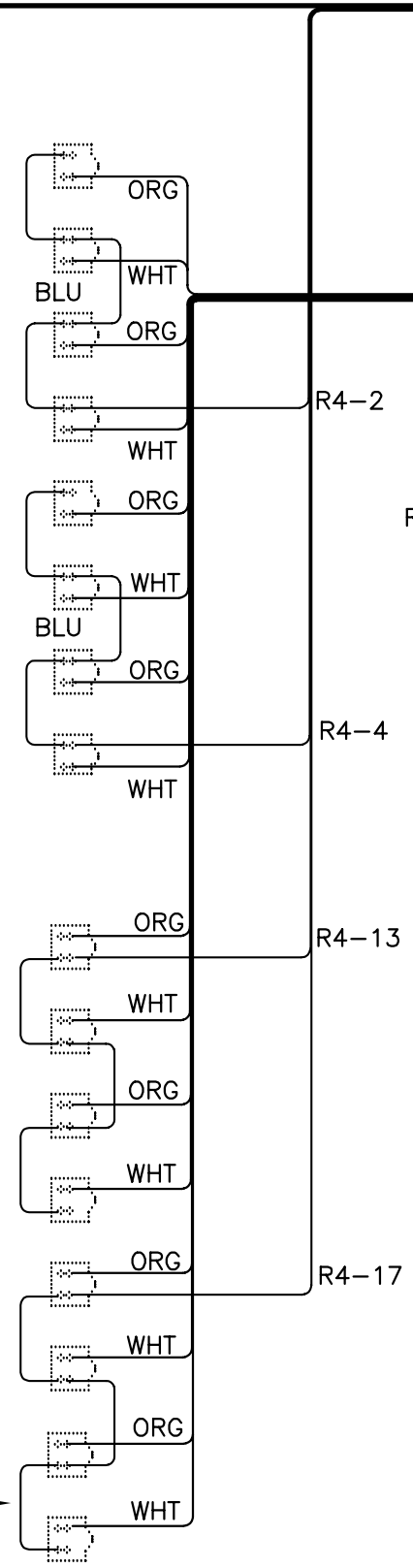
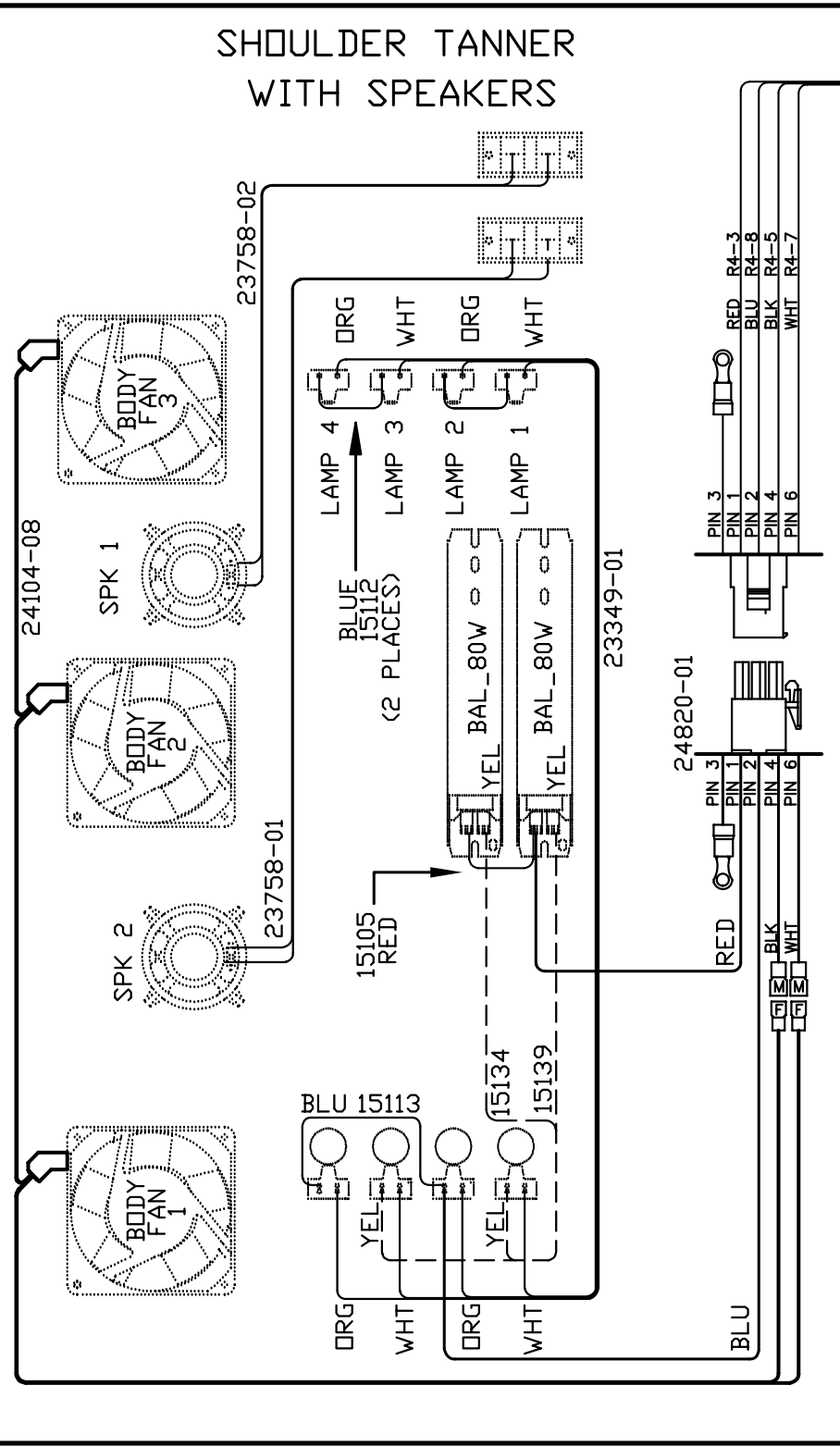

24864-01, REV A  
52 LAMP  
BENCH UNITS &  
SHOULDER TANNER

FRONT OF BED  
(BOTTOM SIDE UP)

**WARNING: ALTERING THE DESIGN, TIMER SYSTEM, OR WIRING FROM THAT SHOWN HEREIN, WILL VOID THE WARRANTY, AND MAY RESULT IN A VIOLATION OF FEDERAL LAW.**

28013-01, REV A  
 BACK LAMP SECTION  
 WIRE DIAGRAM

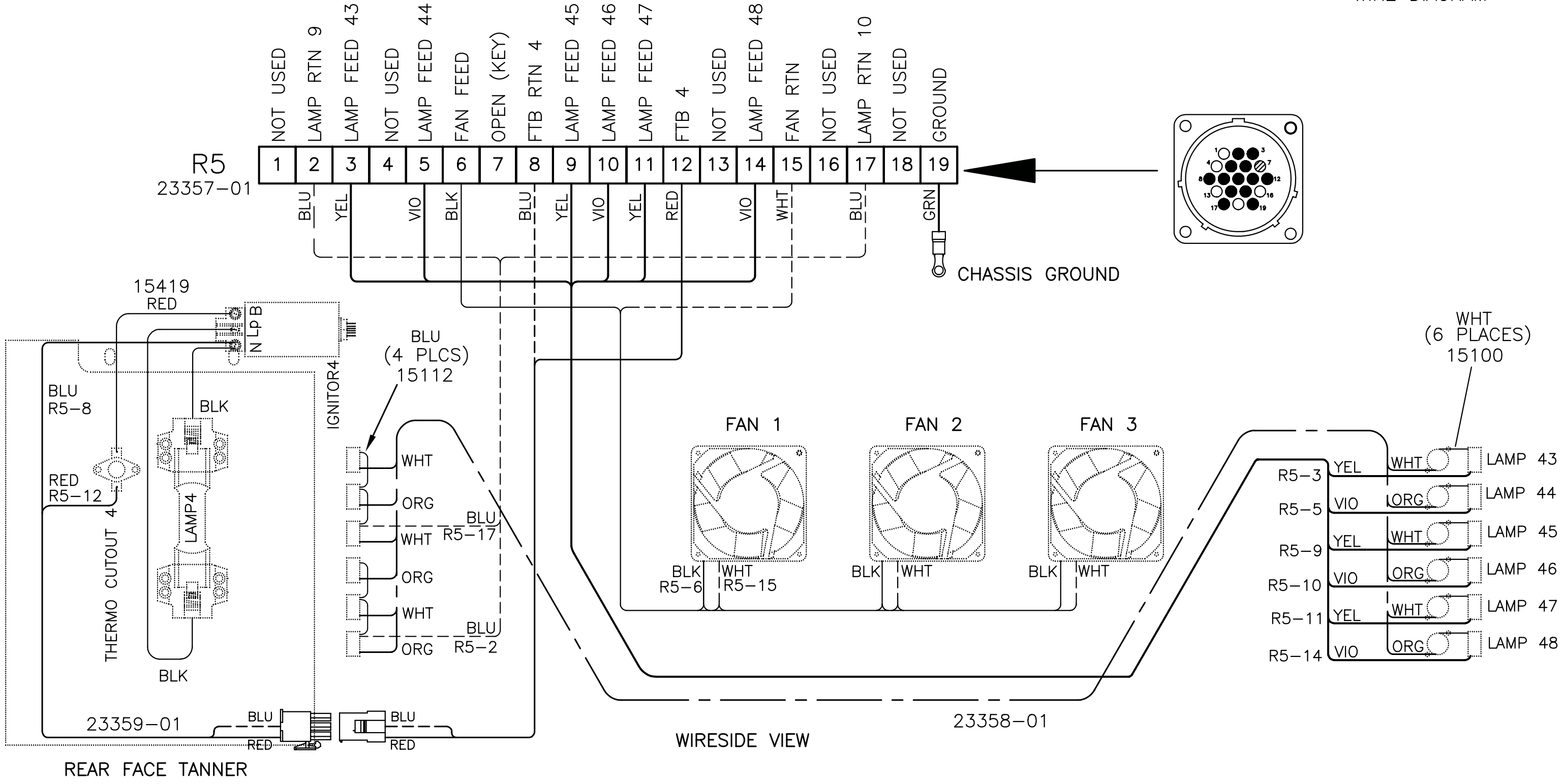

WIRESIDE VIEW

23358-01

REAR FACE TANNER

23359-01

R5  
23357-01

WHT  
(6 PLACES)  
15100

FAN 1

FAN 2

FAN 3

LAMP 43

LAMP 44

LAMP 45

LAMP 46

LAMP 47

LAMP 48

R5-3

R5-5

R5-9

R5-10

R5-11

R5-14

YEL

VIO

YEL

VIO

YEL

VIO

WHT

ORG

WHT

ORG

WHT

ORG

BLU  
(4 PLCS)  
15112

WHT

ORG

WHT

ORG

WHT

ORG

BLU  
R5-17

BLU  
R5-2

BLK  
R5-6

WHT  
R5-15

BLK

WHT

BLK

WHT

15419  
RED

BLU  
R5-8

RED  
R5-12

BLU

RED

BLU

RED

N LPB

IGNITOR4

TANNER

BLK

BLK

BLK

BLK

BLK

BLK

BLK

BLK

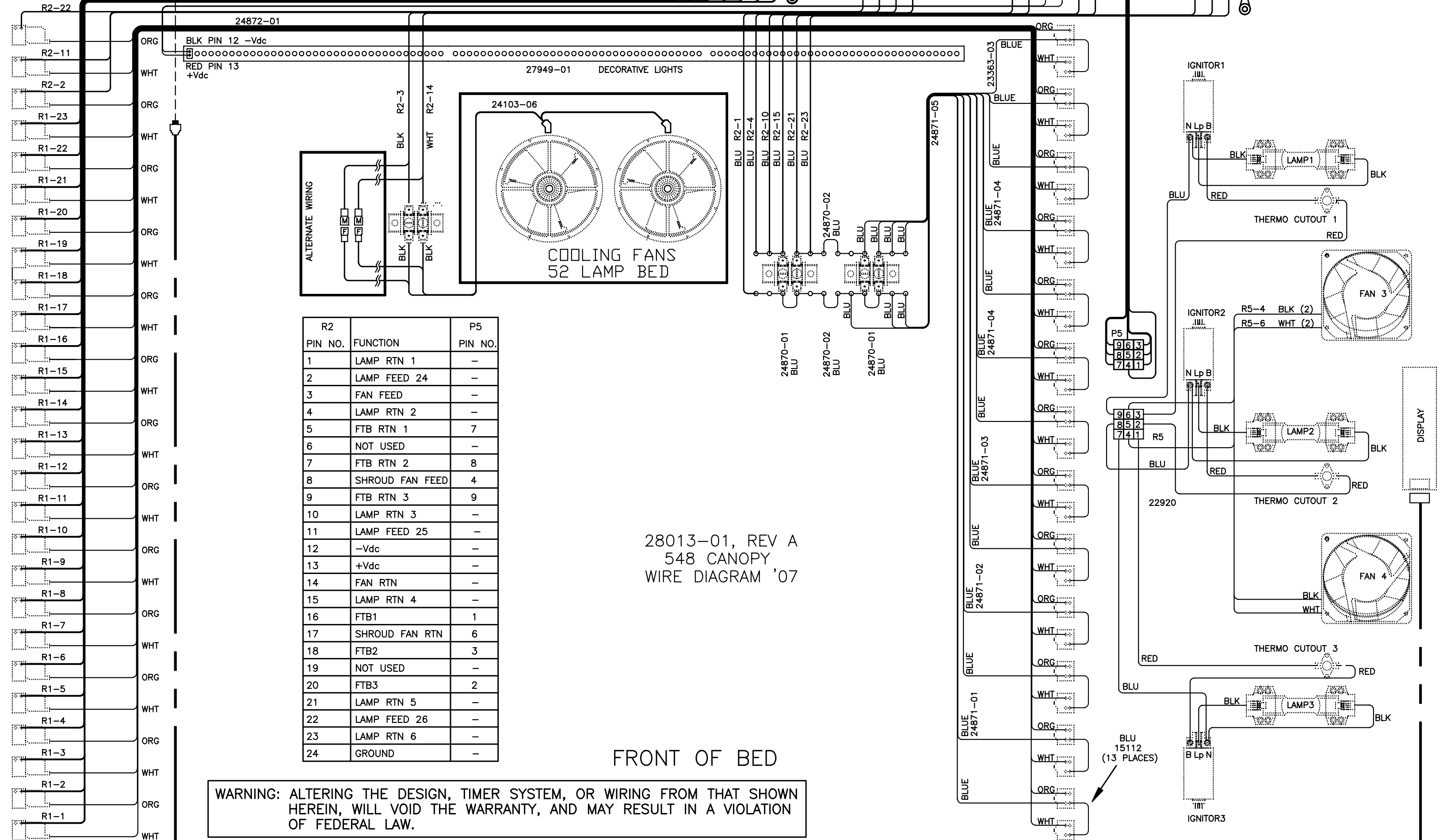
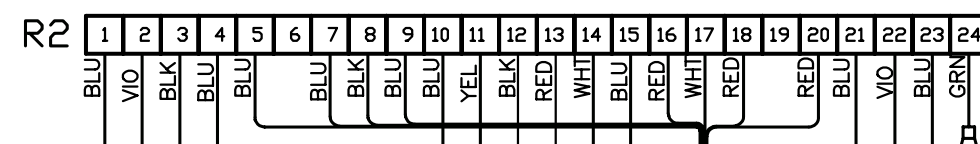
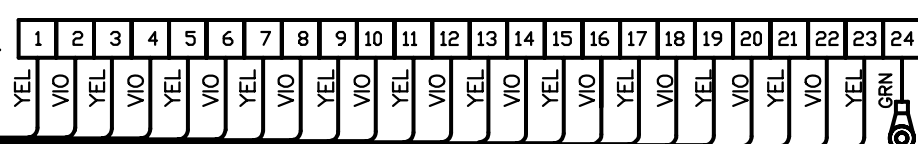

R2 PIN NO.	FUNCTION	P5 PIN NO.
1	LAMP RTN 1	-
2	LAMP FEED 24	-
3	FAN FEED	-
4	LAMP RTN 2	-
5	FTB RTN 1	7
6	NOT USED	-
7	FTB RTN 2	8
8	SHROUD FAN FEED	4
9	FTB RTN 3	9
10	LAMP RTN 3	-
11	LAMP FEED 25	-
12	-Vdc	-
13	+Vdc	-
14	FAN RTN	-
15	LAMP RTN 4	-
16	FTB1	1
17	SHROUD FAN RTN	6
18	FTB2	3
19	NOT USED	-
20	FTB3	2
21	LAMP RTN 5	-
22	LAMP FEED 26	-
23	LAMP RTN 6	-
24	GROUND	-

28013-01, REV A  
548 CANOPY  
WIRE DIAGRAM '07

FRONT OF BED

**WARNING: ALTERING THE DESIGN, TIMER SYSTEM, OR WIRING FROM THAT SHOWN HEREIN, WILL VOID THE WARRANTY, AND MAY RESULT IN A VIOLATION OF FEDERAL LAW.**