

TO TIMER
24286-01

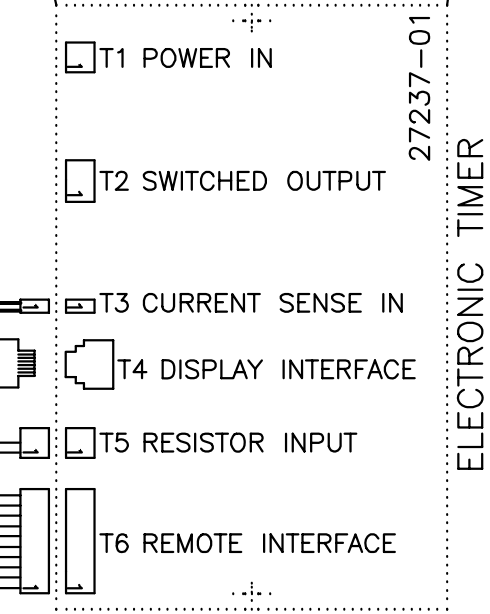
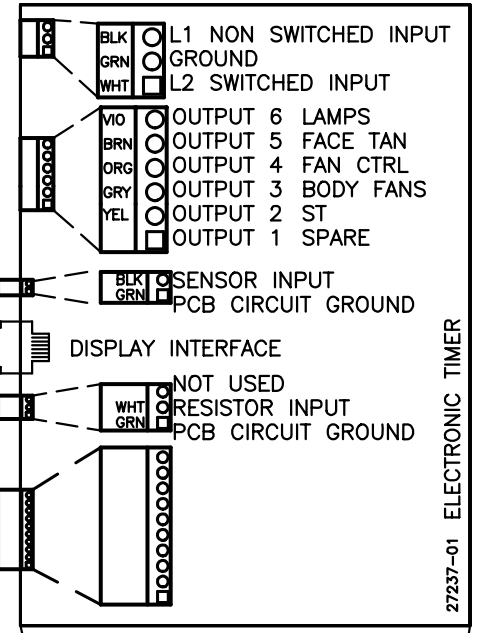

24488-03

27239-01

24486-03

27159-02

27237-01 ELECTRONIC TIMER

27237-01

ELECTRONIC TIMER

24487-01

POWER IN
23878-02

27412-01, REV A '06
UPPER LEVEL TRAY
336 LAMP UNIT

CURRENT
TORROID

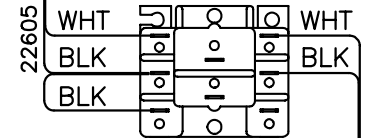
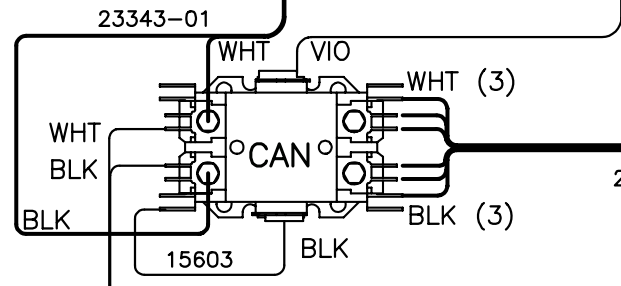
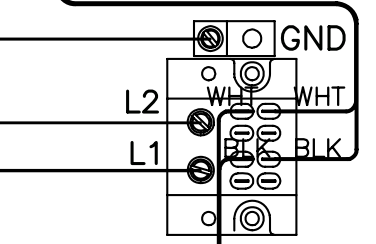
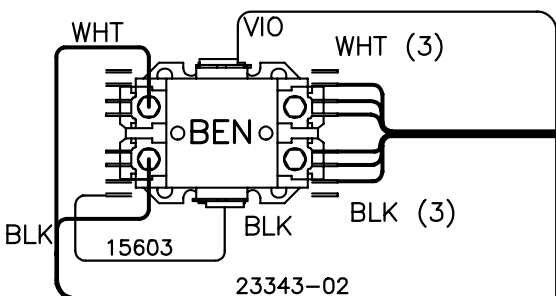
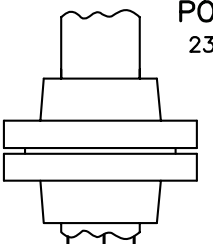
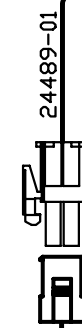

FAN RELAY

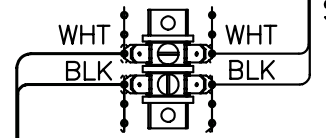

24105-04

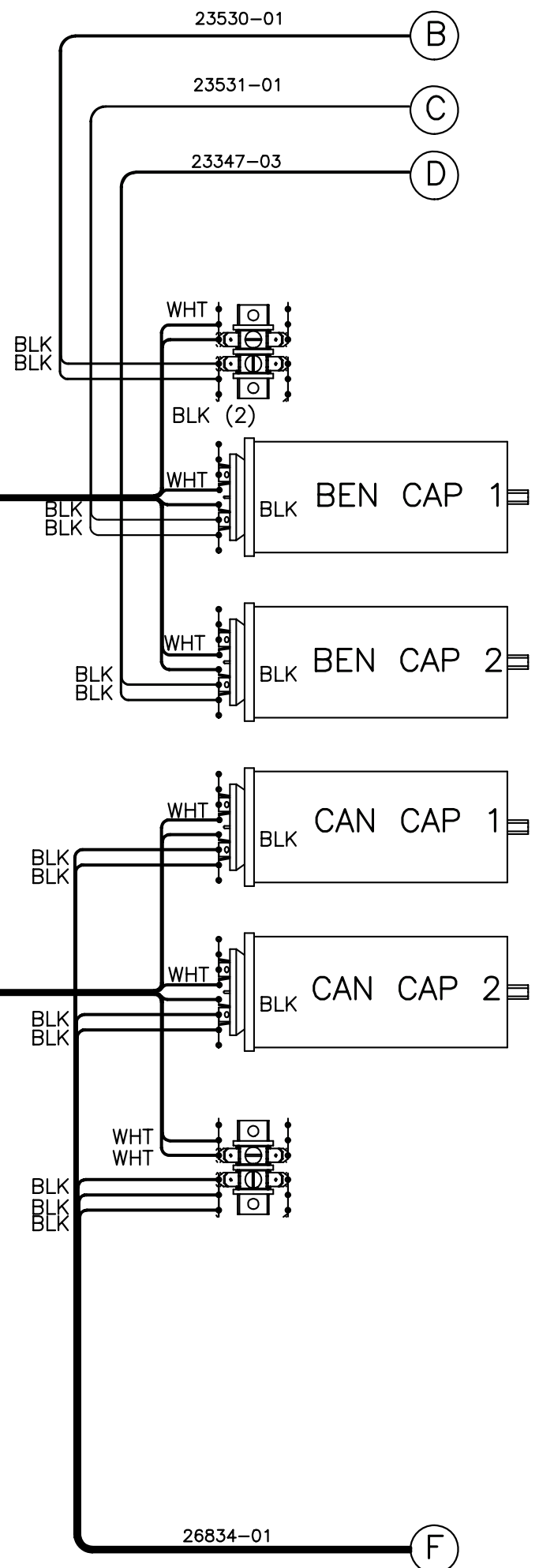

23530-01

23531-01

23347-03

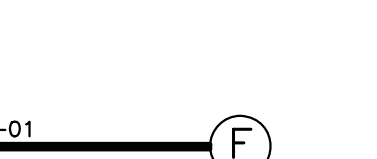
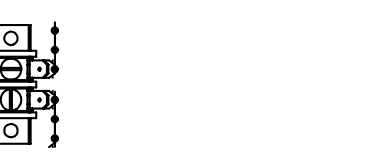
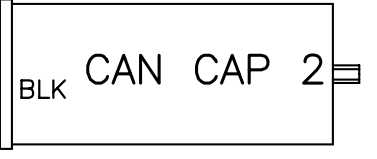
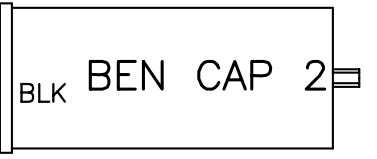
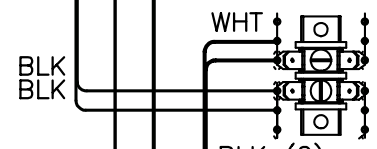

26834-01

26834-01

P2
26835-01

LAMP RETURN	KEY	LAMP RETURN	LAMP RETURN	LAMP RETURN	LAMP RETURN	LAMP RETURN	LAMP RETURN	LAMP RETURN	LAMP RETURN	LAMP RETURN	NOT USED	NOT USED	NOT USED	NOT USED	FAN FEED	FAN RETURN	GROUND	
1	2	3	4	5	6	7	8	9	10	11	12	13	14	15	16	17	18	19
BLU	BLU	BLU	BLU	BLU	BLU	BLU	BLU	BLU	BLU	BLU					BLK	WHT	GRN	

P4
26862-01

NOT USED	LAMP RTN 5	ST FEED 1	LAMP RTN 6	BODY FAN FEED	FAN FEED	BODY FAN RTN	ST RTN	KEY	NOT USED	NOT USED	NOT USED	LAMP RTN 7	HOUR CTR FEED	FAN RTN	HOUR CTR RTN	LAMP RTN 8	NOT USED	GROUND
1	2	3	4	5	6	7	8	9	10	11	12	13	14	15	16	17	18	19
BLU	RED	BLU	BLK	BLK	WHT	BLU						BLU	BLK	WHT	WHT	BLU		GRN

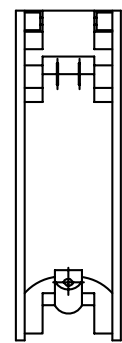
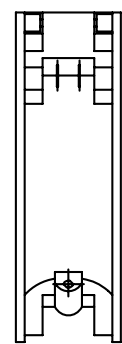
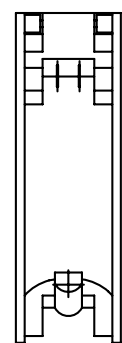
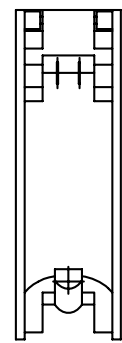

FRAME GROUND

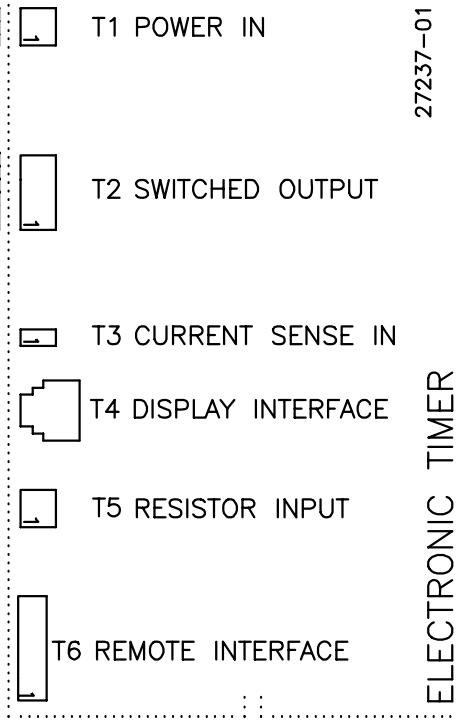

27412-01, REV A '06
UPPER LEVEL TRAY
336 LAMP UNIT

24873-01

23335-01

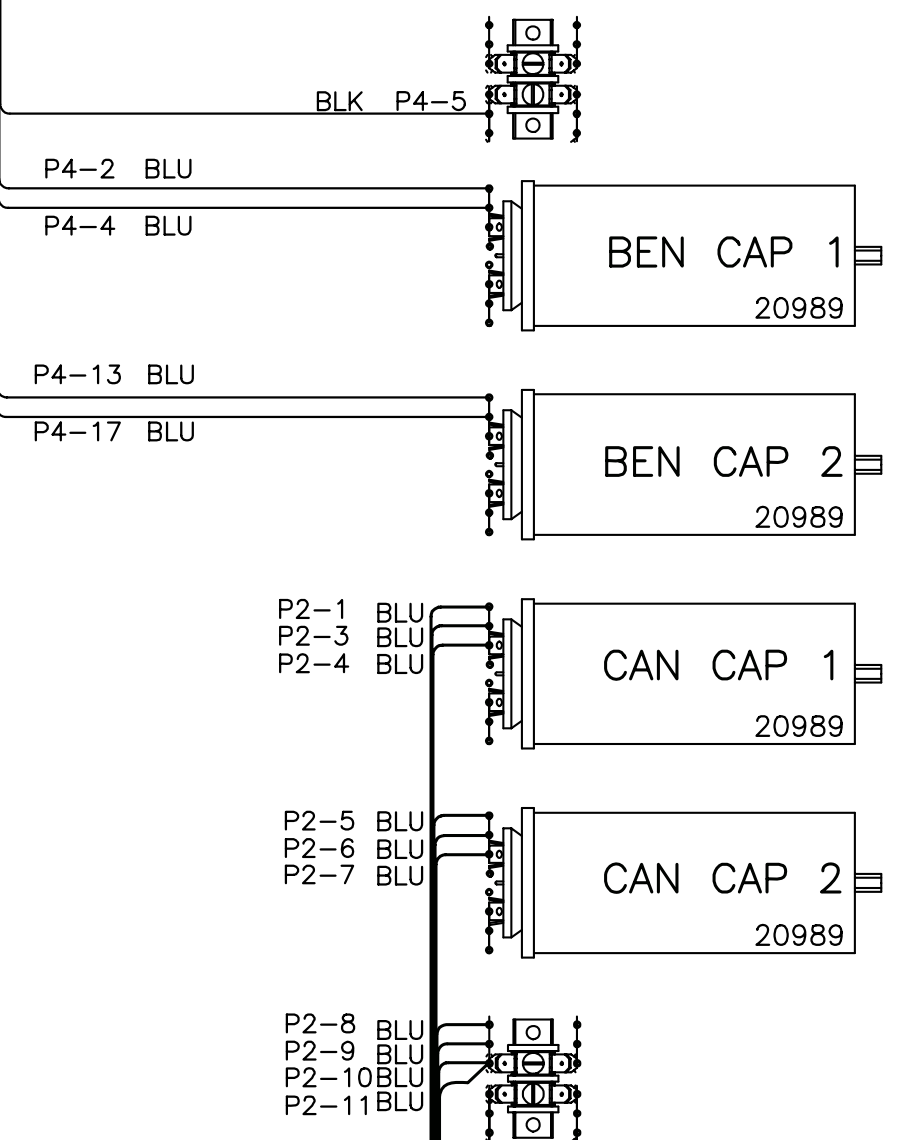
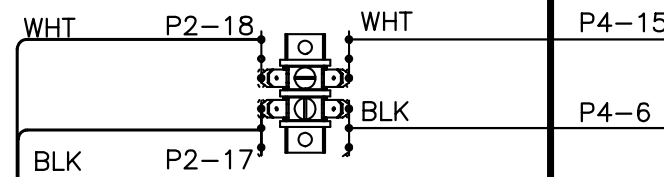
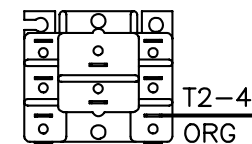
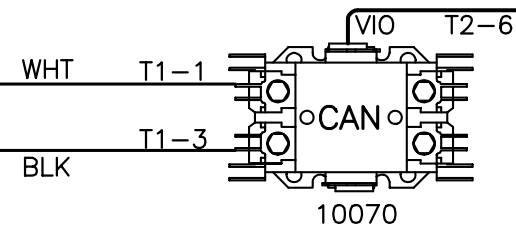
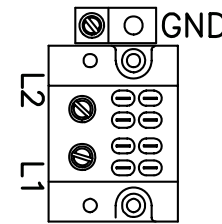
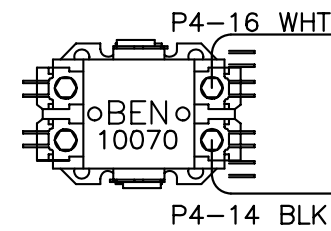
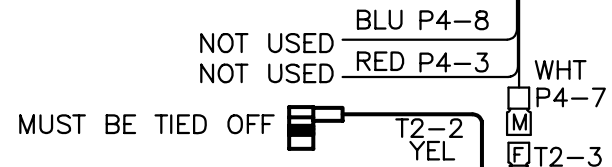

WARNING: ALTERING THE DESIGN, TIMER SYSTEM, OR WIRING FROM THAT SHOWN HEREIN, WILL VOID THE WARRANTY, AND MAY RESULT IN A VIOLATION OF FEDERAL LAW.

P1
26836-01

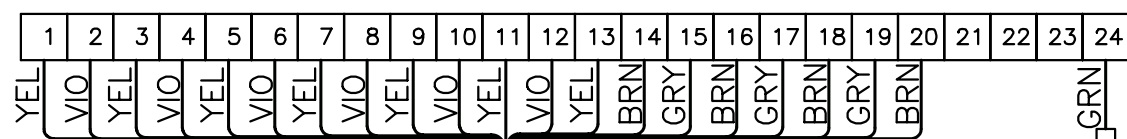

P3
26861-01

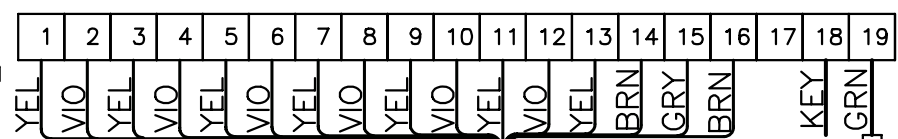

○ FRAME GROUND

○ FRAME GROUND

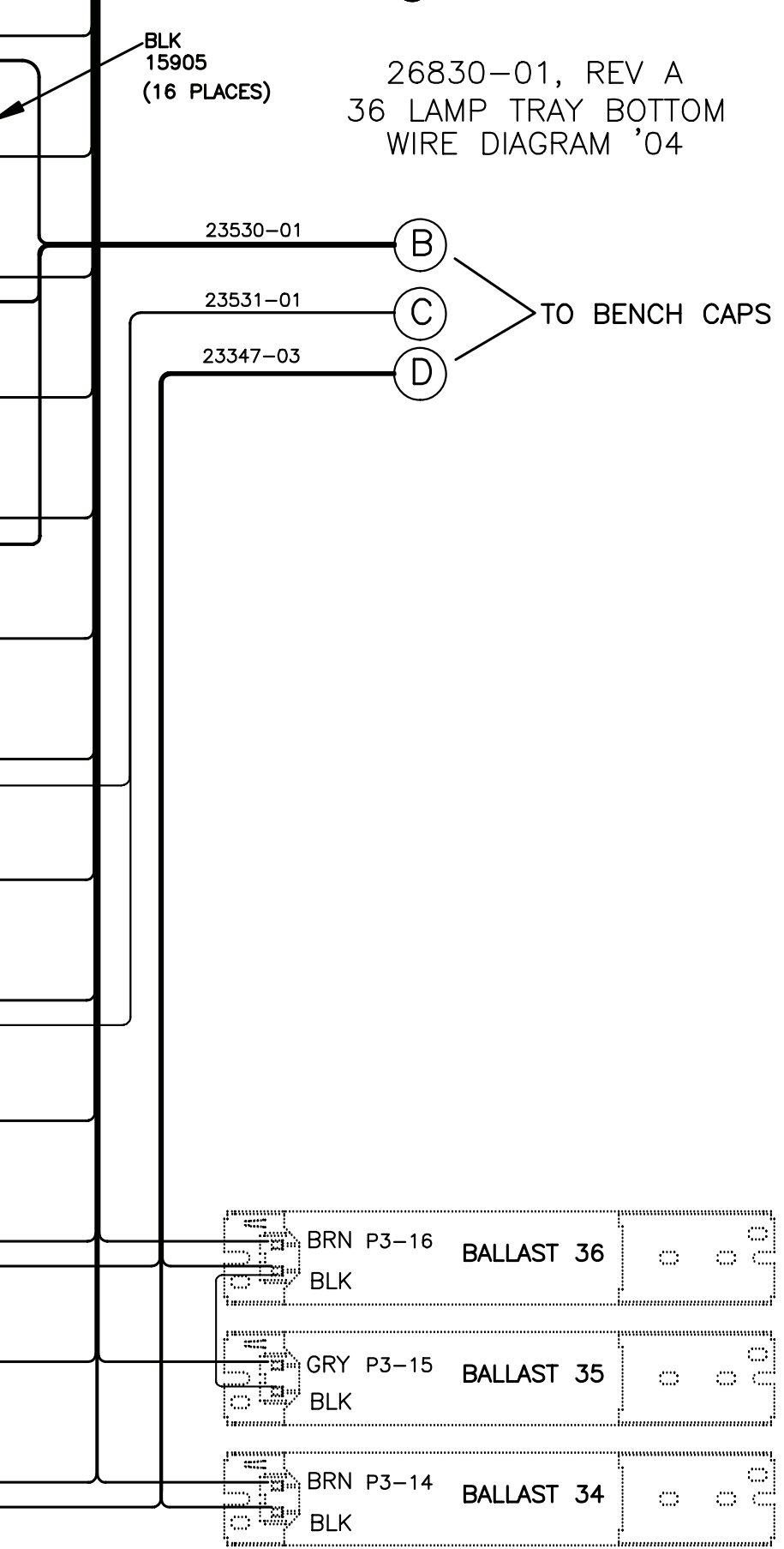
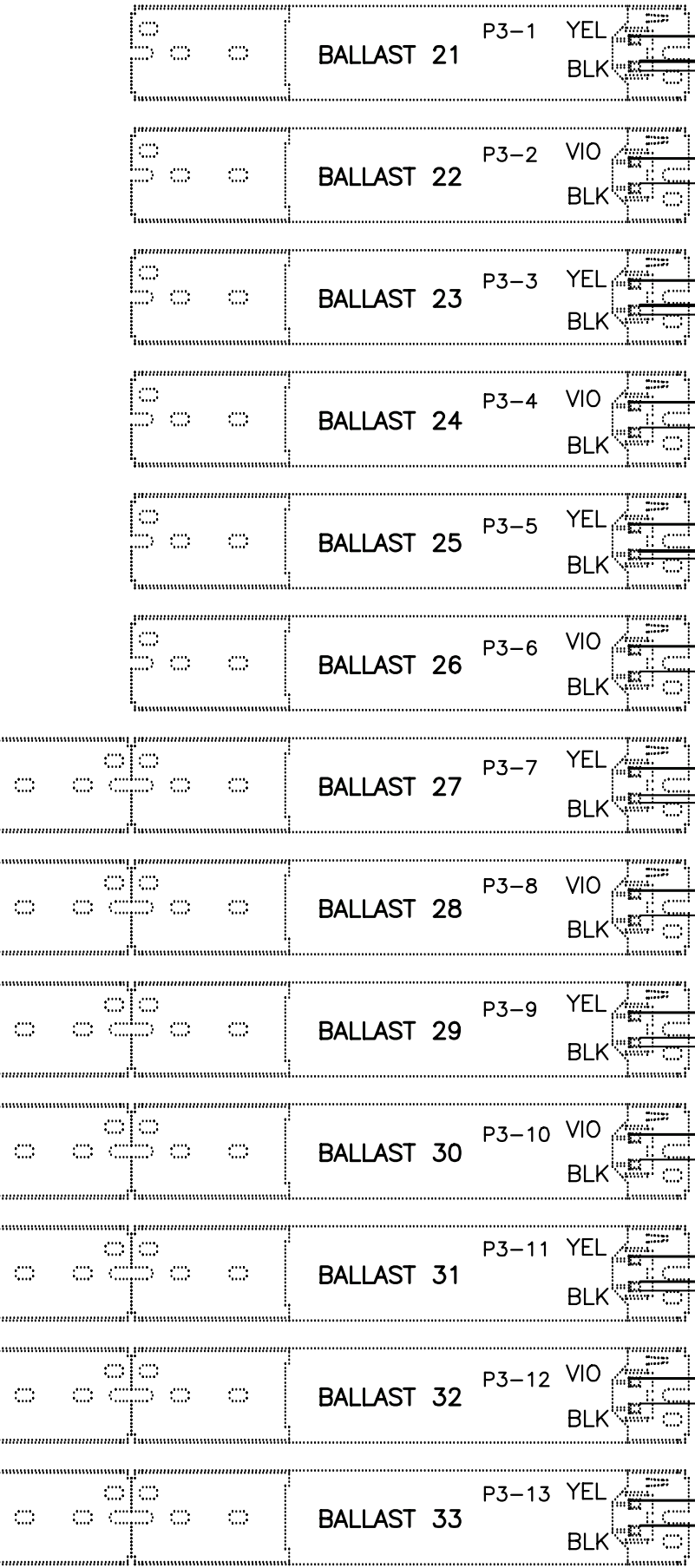
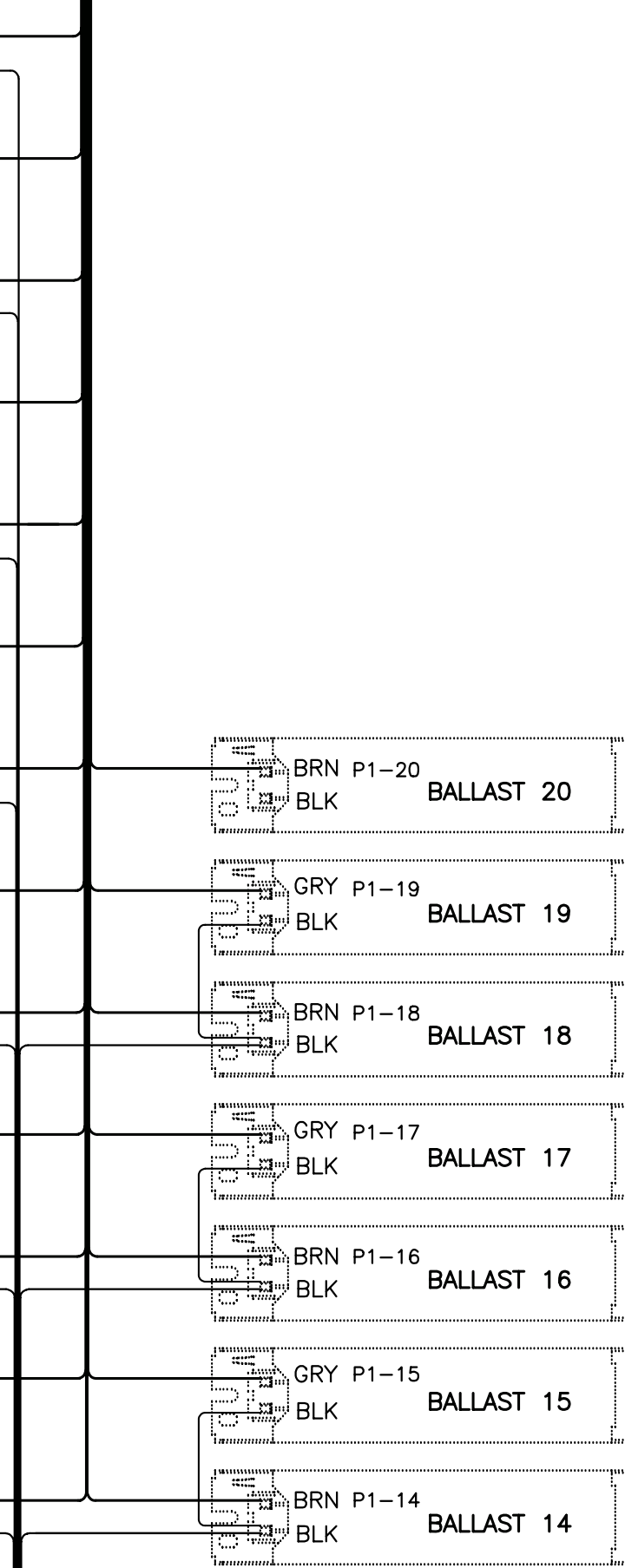
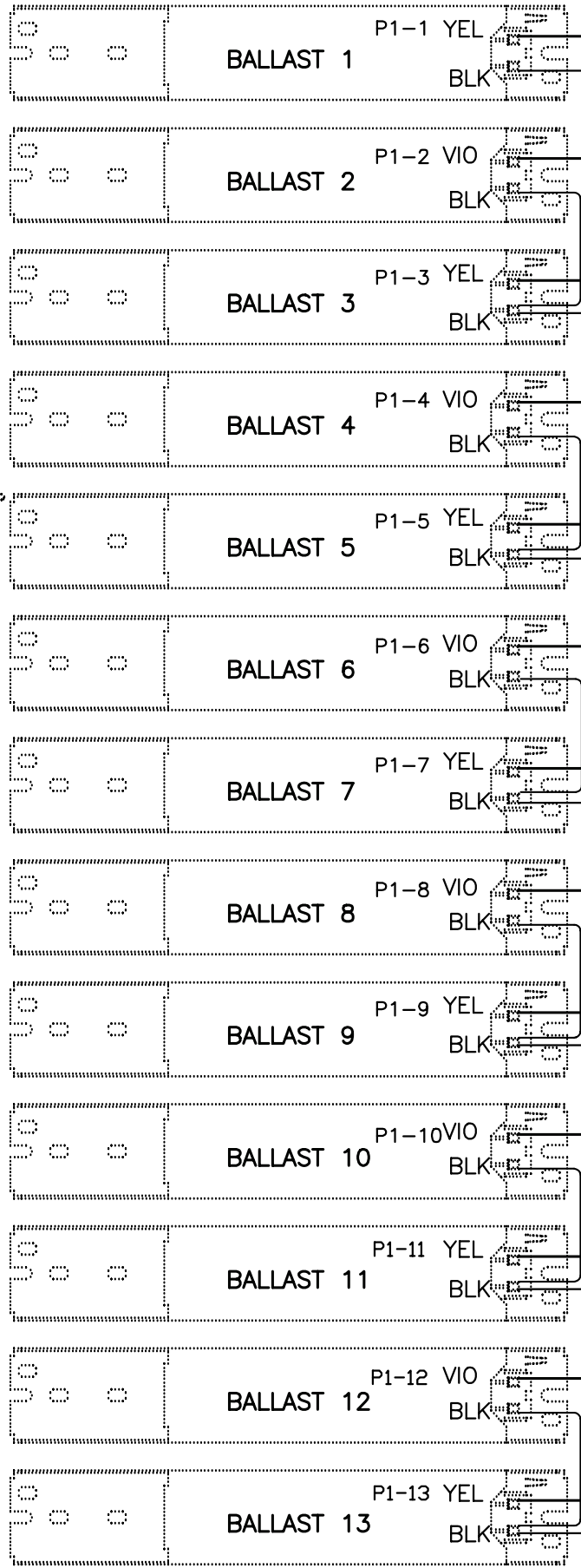

BLK 15905 (16 PLACES)

26830-01, REV A
36 LAMP TRAY BOTTOM
WIRE DIAGRAM '04

23530-01

23531-01

23347-03

(B)

(C)

(D)

TO BENCH CAPS

26834-01

(F)

TO CANOPY CAPS

R3
26863-01

1	2	3	4	5	6	7	8	9	10	11	12	13	14	15	16	17	18	19
YEL	VIO	YEL	VIO	YEL	VIO	YEL	VIO	YEL	VIO	YEL	VIO	YEL	VIO	YEL	VIO	GRN		

1	2	3	4	5	6	7	8	9	10	11	12	13	14	15	16	17	18	19
BLU	BLU	BLK	BLK	WHT								BLU	BLK	WHT	WHT	BLU	GRN	
NOT USED	LAMP RTN	LAMP RTN	B FAN FEED	FAN FEED	B FAN RTN	KEY	NOT USED	NOT USED	NOT USED	LAMP RTN	H CTR FEED	FAN RTN	H CTR RTN	LAMP RTN	NOT USED	GROUND		

R4
26864-01

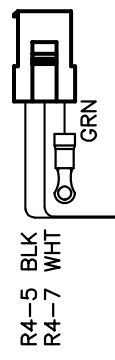
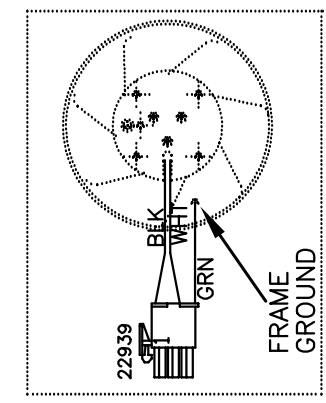
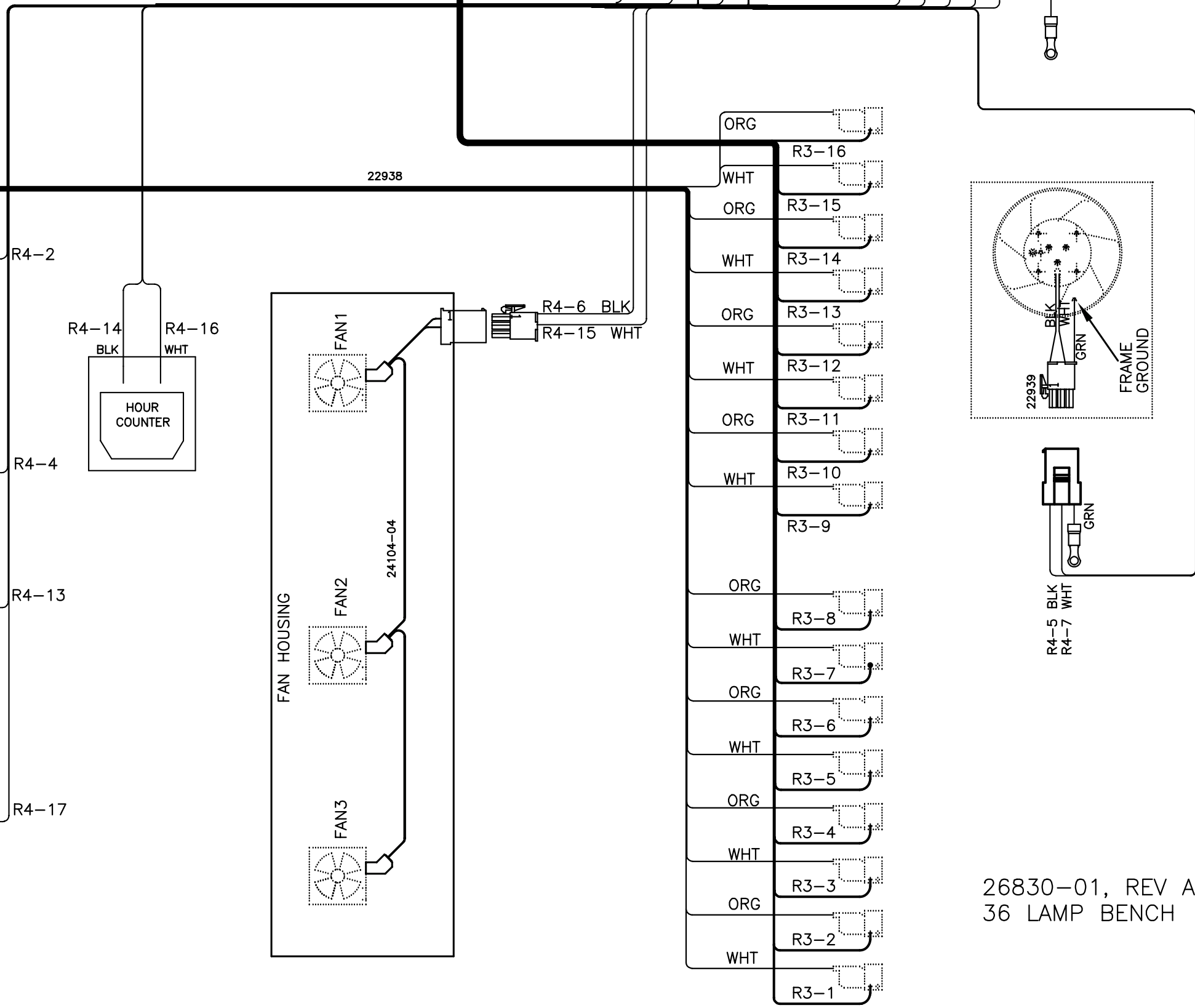
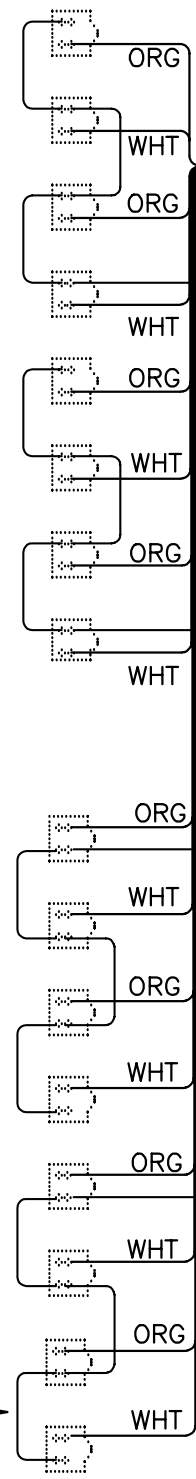

26830-01, REV A
36 LAMP BENCH

15902
BLU
12 PLACES

FRONT OF BED
(BOTTOM SIDE UP)

WARNING: ALTERING THE DESIGN, TIMER SYSTEM, OR WIRING FROM THAT SHOWN HEREIN, WILL VOID THE WARRANTY, AND MAY RESULT IN A VIOLATION OF FEDERAL LAW.

TO TIMER
24286-01



R1
26803-01

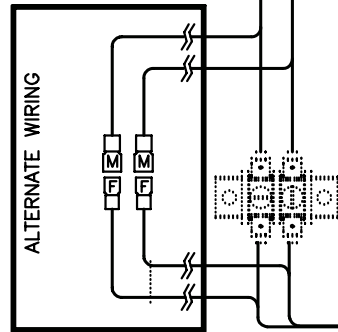
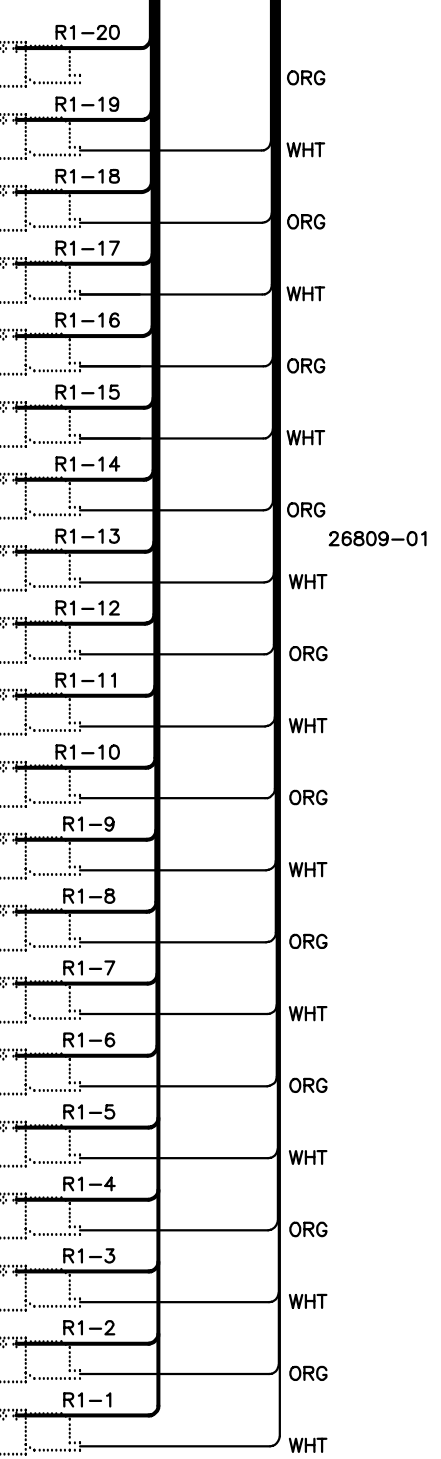
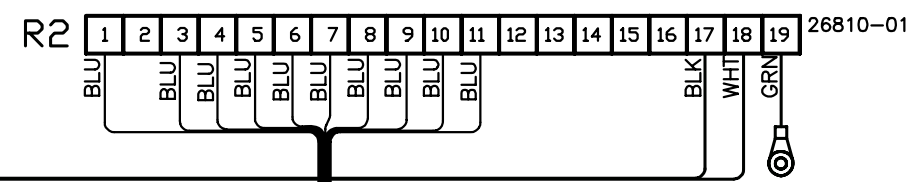
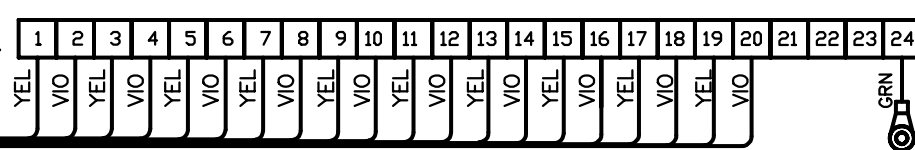

BLK R2-17
WHT R2-18

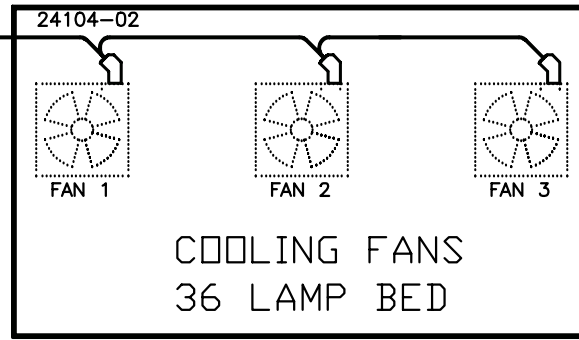

COOLING FANS
36 LAMP BED

26831-01, REV A
36 LAMP CANOPY
WIRE DIAGRAM

R2 PIN NO.	FUNCTION
1	LAMP RETURN
2	OPEN (KEY)
3	LAMP RETURN
4	LAMP RETURN
5	LAMP RETURN
6	LAMP RETURN
7	LAMP RETURN
8	LAMP RETURN
9	LAMP RETURN
10	LAMP RETURN
11	LAMP RETURN
12	-
13	-
14	-
15	-
16	-
17	FAN FEED
18	FAN RETURN
19	GROUND

FRONT OF BED

WARNING: ALTERING THE DESIGN, TIMER SYSTEM, OR WIRING FROM THAT SHOWN HEREIN, WILL VOID THE WARRANTY, AND MAY RESULT IN A VIOLATION OF FEDERAL LAW.

