

26939-01, REV A
UPPER LEVEL TRAY
336 LAMP UNIT
WIRE DIAGRAM

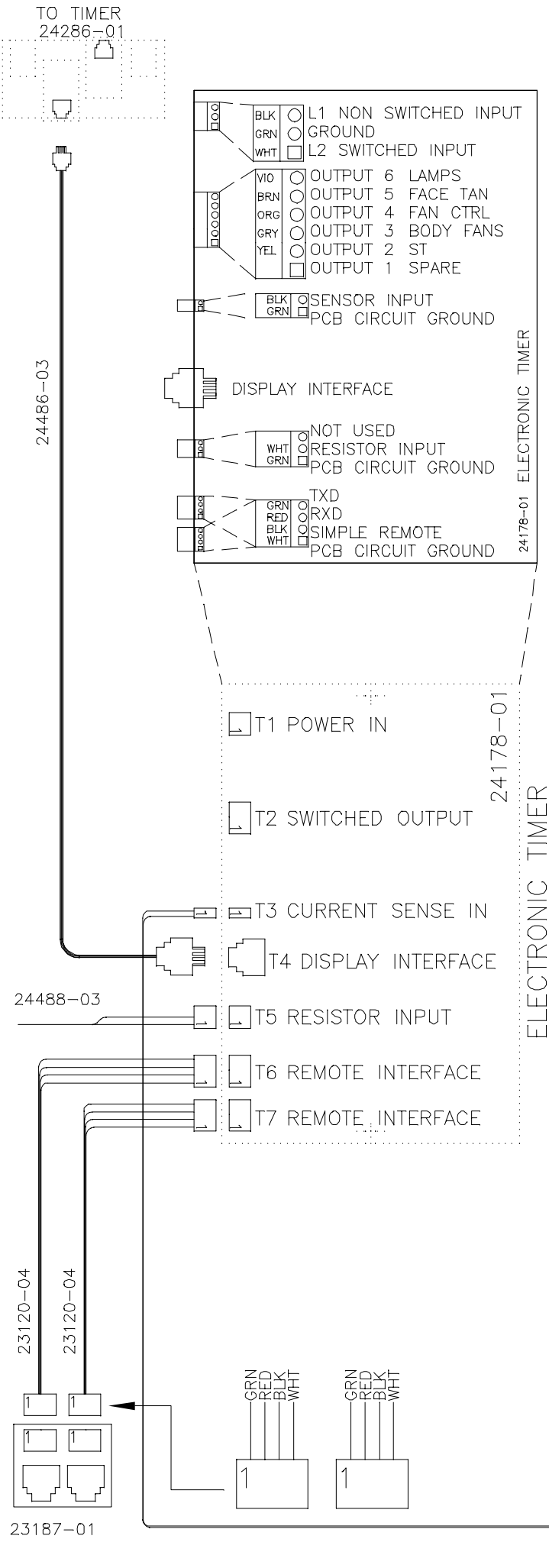
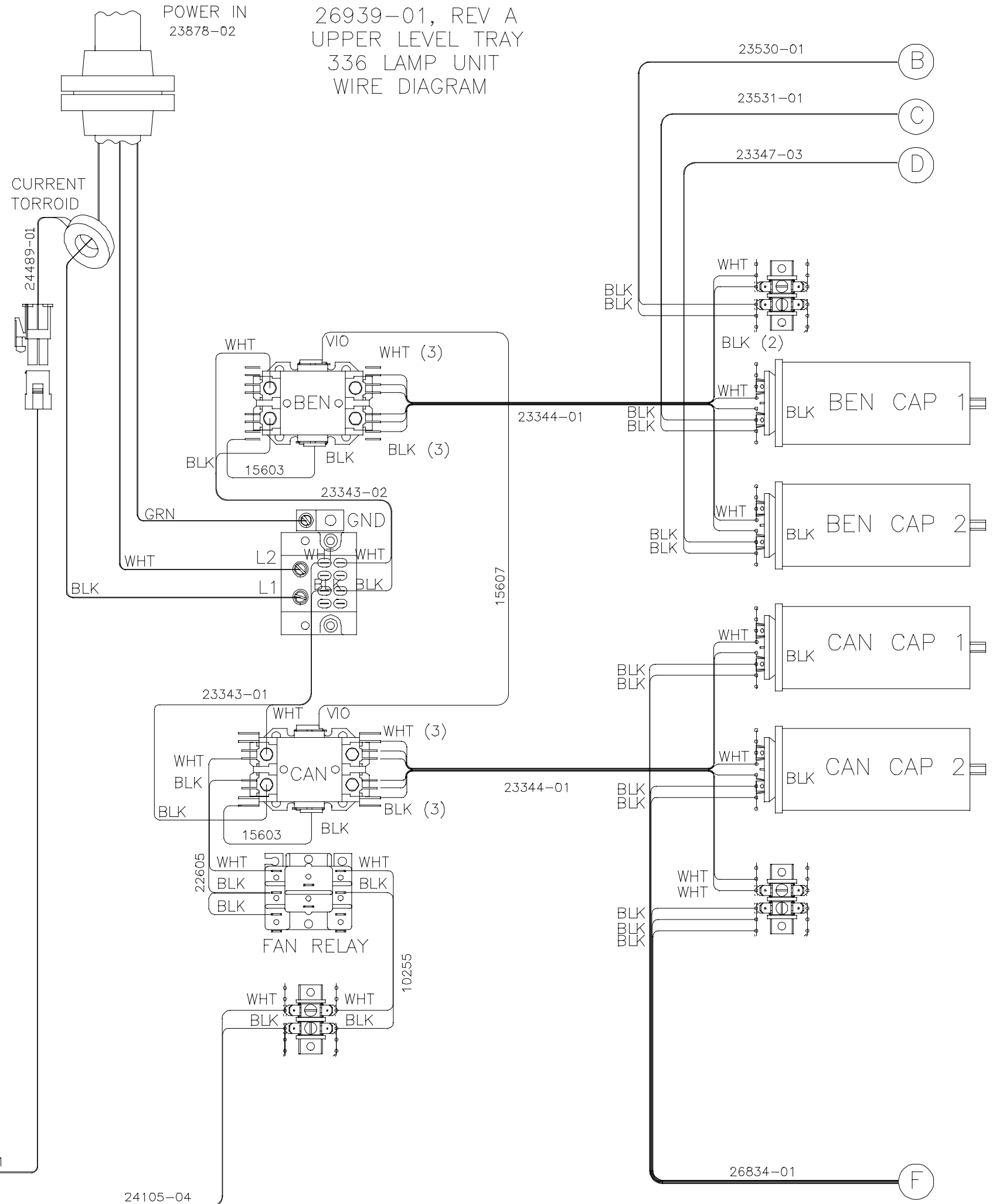

P2
26835-01

1	2	3	4	5	6	7	8	9	10	11	12	13	14	15	16	17	18	19
BLU	BLU	BLU	BLU	BLU	BLU	BLU	BLU	BLU	BLU	BLU						BLK	WHT	GRN
LAMP RETURN	KEY	LAMP RETURN	LAMP RETURN	LAMP RETURN	LAMP RETURN	LAMP RETURN	LAMP RETURN	LAMP RETURN	LAMP RETURN	LAMP RETURN	NOT USED	NOT USED	NOT USED	NOT USED	NOT USED	FAN FEED	FAN RETURN	GROUND

P4
26862-01

1	2	3	4	5	6	7	8	9	10	11	12	13	14	15	16	17	18	19
BLU	RED	BLU	BLK	BLK	WHT	BLU					BLU	BLK	WHT	WHT	BLU		GRN	
NOT USED	LAMP RTN 5	ST FEED 1	LAMP RTN 6	BODY FAN FEED	FAN FEED	BODY FAN RTN	ST RTN	KEY	NOT USED	NOT USED	NOT USED	LAMP RTN 7	HOUR CTR FEED	FAN RTN	HOUR CTR RTN	LAMP RTN 8	NOT USED	GROUND

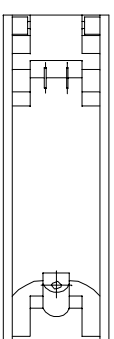
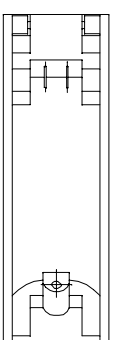
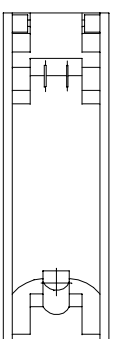
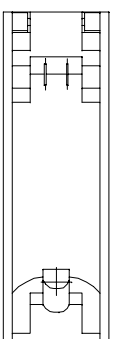

FRAME GROUND

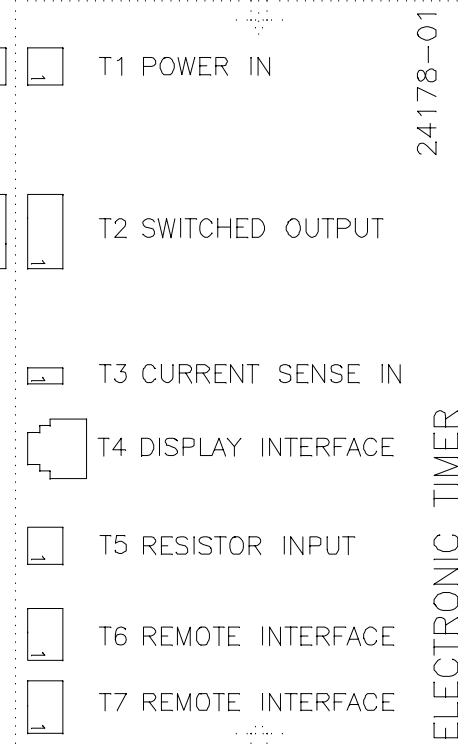

26939-01, REV A
UPPER LEVEL TRAY
336 LAMP UNIT
WIRE DIAGRAM

24873-01

23335-01

NOT USED BLU P4-8
NOT USED RED P4-3
NOT USED WHT P4-7
MUST BE TIED OFF T2-2 YEL
T2-3 GRY

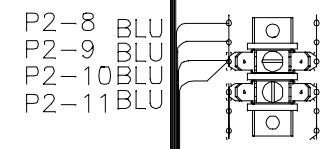
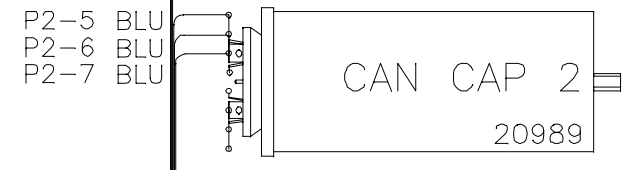
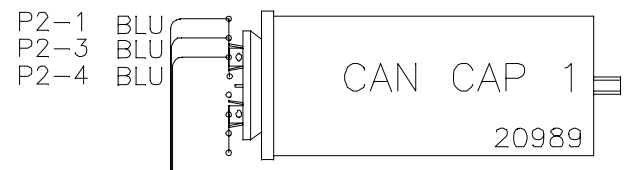
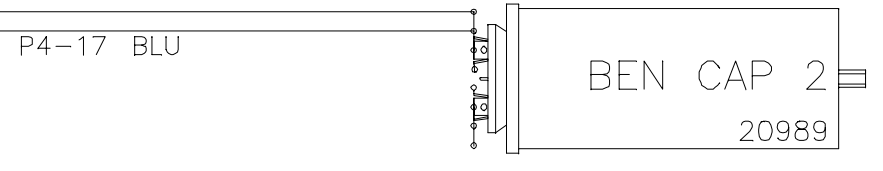
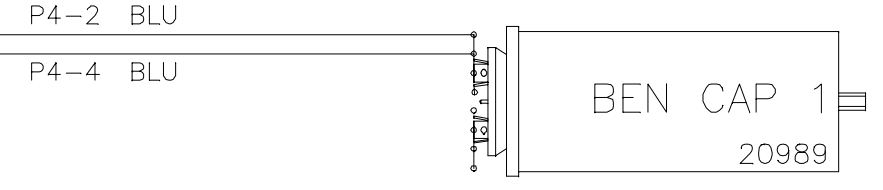
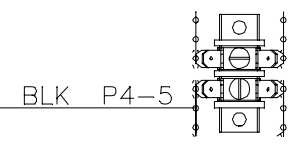
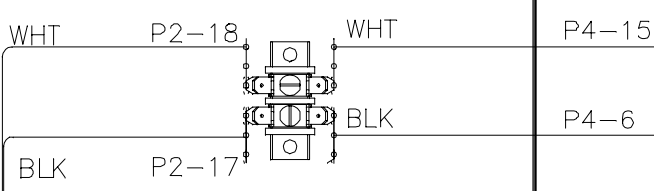
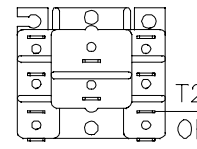
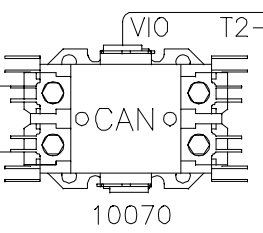
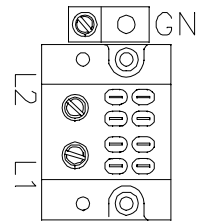
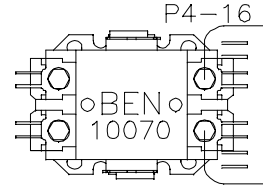

WARNING: ALTERING THE DESIGN, TIMER SYSTEM, OR WIRING FROM THAT SHOWN HEREIN, WILL VOID THE WARRANTY, AND MAY RESULT IN A VIOLATION OF FEDERAL LAW.

P1
26836-01

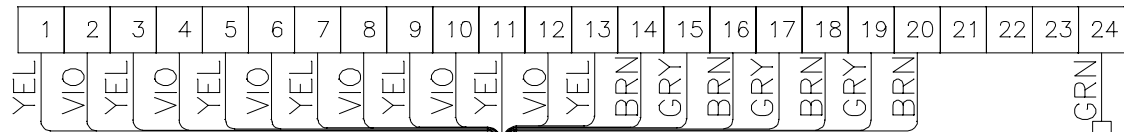

○ FRAME GROUND

P3
26861-01

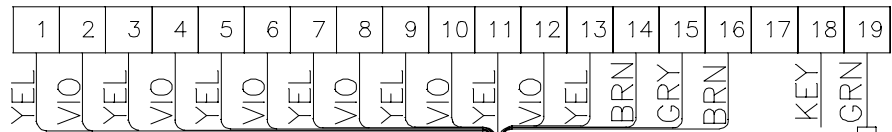

○ FRAME GROUND

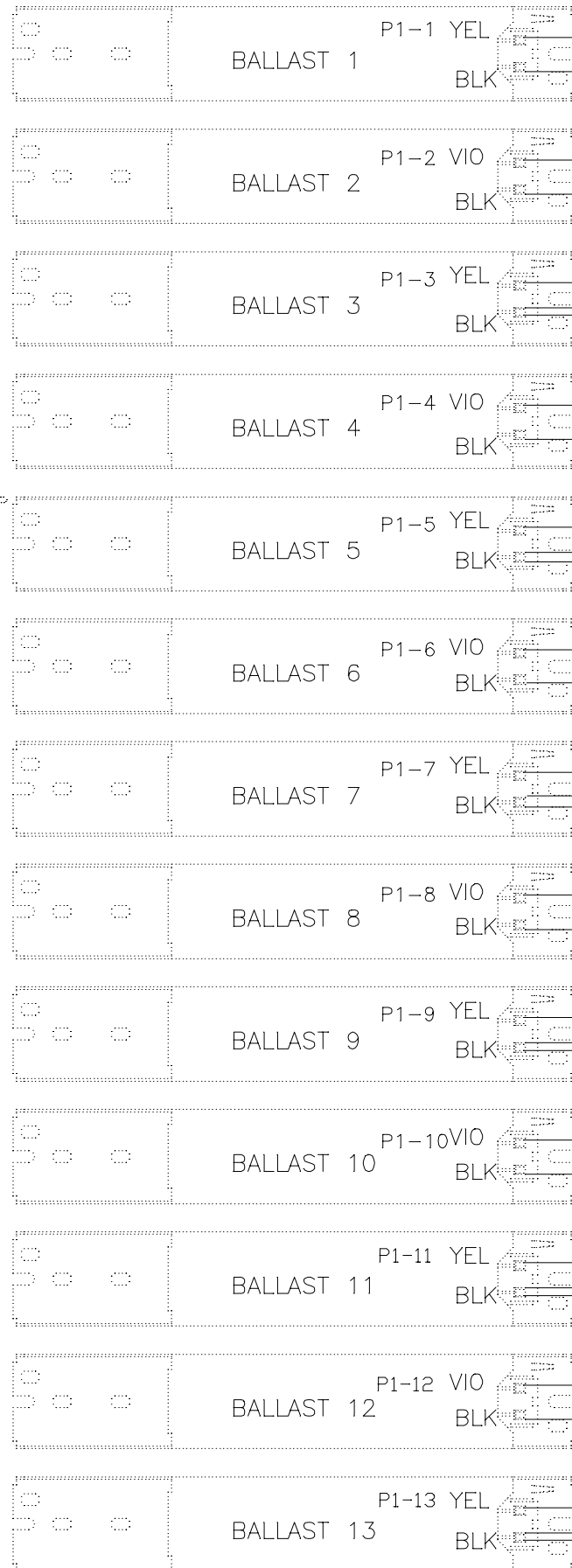

26834-01

(F) TO CANOPY CAPS

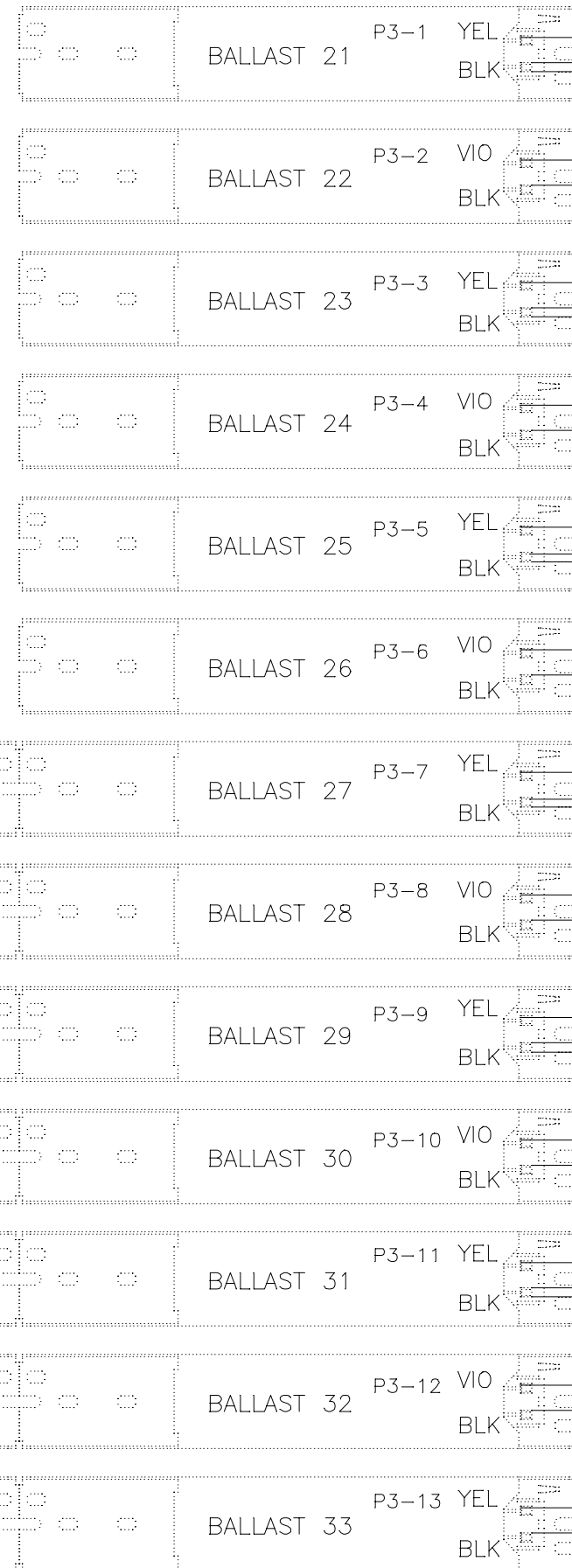

BLK
15905
(16 PLACES)

26830-01, REV A
36 LAMP TRAY BOTTOM
WIRE DIAGRAM '04

23530-01



23531-01



23347-03



TO BENCH CAPS

BRN P3-16
BLK BALLAST 36

GRY P3-15
BLK BALLAST 35

BRN P3-14
BLK BALLAST 34

R3
26863-01

1	2	3	4	5	6	7	8	9	10	11	12	13	14	15	16	17	18	19
YEL	VIO	YEL	VIO	YEL	VIO	YEL	VIO	YEL	VIO	YEL	VIO	YEL	VIO	YEL	VIO	GRN		

1	2	3	4	5	6	7	8	9	10	11	12	13	14	15	16	17	18	19
BLU	BLU	BLK	BLK	WHT								BLU	BLK	WHT	WHT	BLU	GRN	
NOT USED	LAMP RTN	LAMP RTN	LAMP RTN	B FAN FEED	FAN FEED	B FAN RTN		KEY	NOT USED	NOT USED	NOT USED	LAMP RTN	H CTR FEED	FAN RTN	H CTR RTN	LAMP RTN	NOT USED	GROUND

R4
26864-01

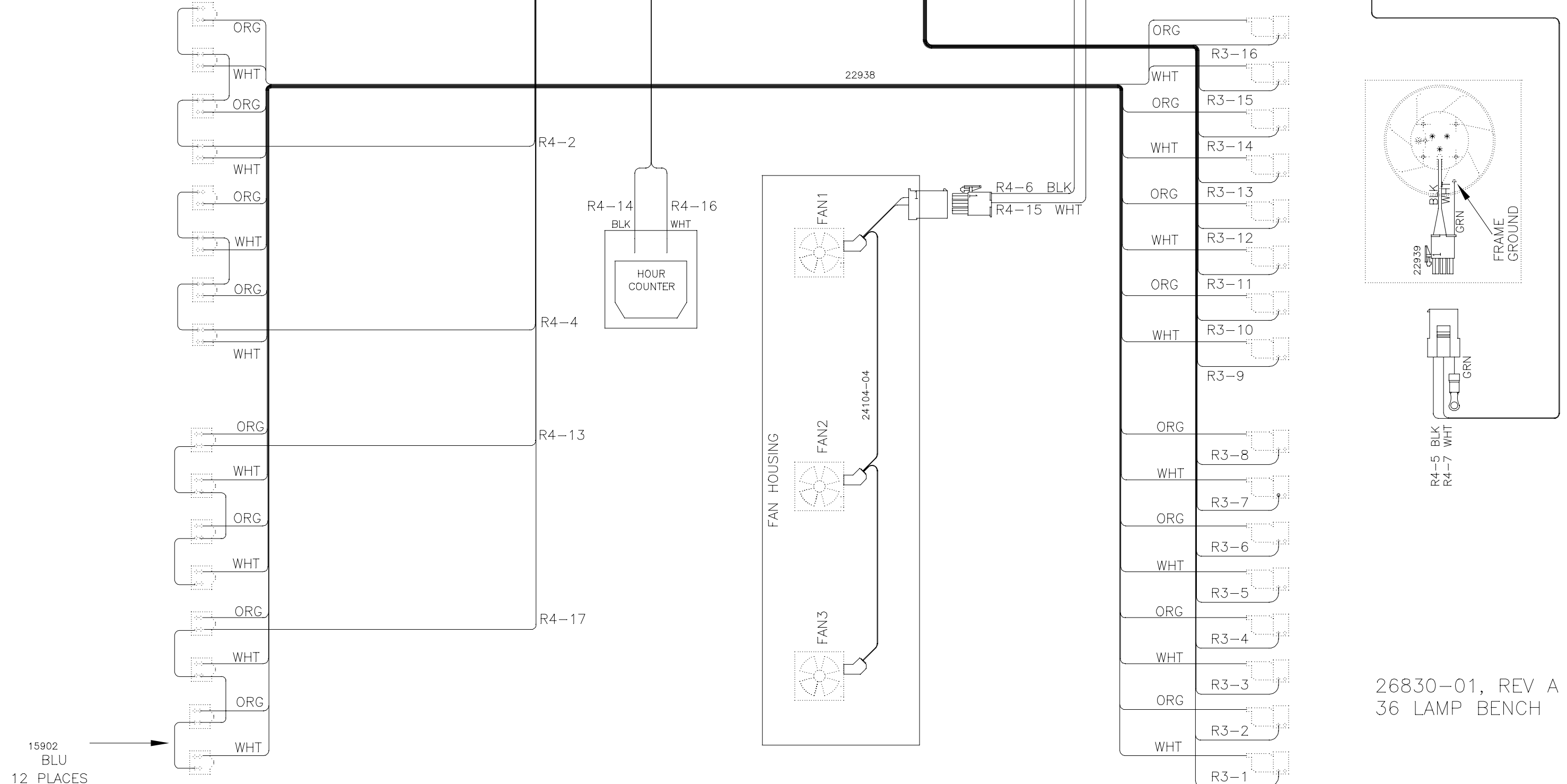

FRONT OF BED
(BOTTOM SIDE UP)

WARNING: ALTERING THE DESIGN, TIMER SYSTEM, OR WIRING FROM THAT SHOWN HEREIN, WILL VOID THE WARRANTY, AND MAY RESULT IN A VIOLATION OF FEDERAL LAW.

15902
BLU
12 PLACES

26830-01, REV A
36 LAMP BENCH

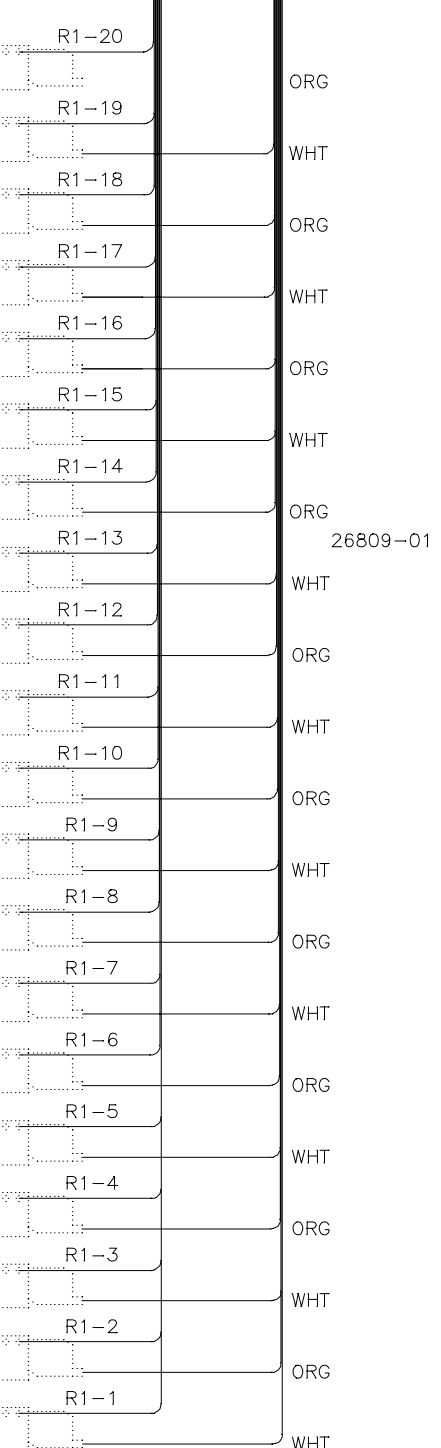
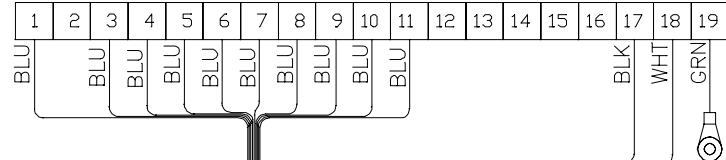
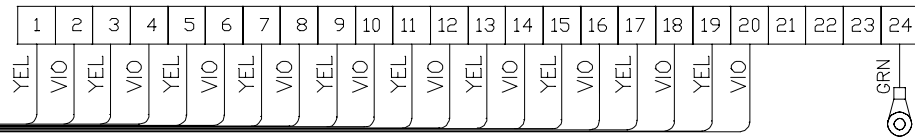

26809-01

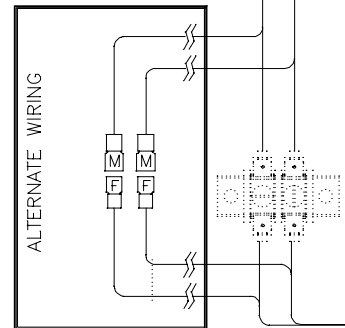

BLK R2-17
WHT R2-18

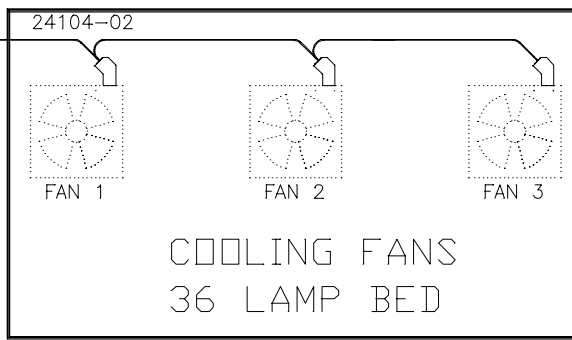

COOLING FANS
36 LAMP BED

26831-01, REV A
36 LAMP CANOPY
WIRE DIAGRAM

FRONT OF BED

R2 PIN NO.	FUNCTION
1	LAMP RETURN
2	OPEN (KEY)
3	LAMP RETURN
4	LAMP RETURN
5	LAMP RETURN
6	LAMP RETURN
7	LAMP RETURN
8	LAMP RETURN
9	LAMP RETURN
10	LAMP RETURN
11	LAMP RETURN
12	-
13	-
14	-
15	-
16	-
17	FAN FEED
18	FAN RETURN
19	GROUND

WARNING: ALTERING THE DESIGN, TIMER SYSTEM, OR WIRING FROM THAT SHOWN
HEREIN, WILL VOID THE WARRANTY, AND MAY RESULT IN A VIOLATION
OF FEDERAL LAW.

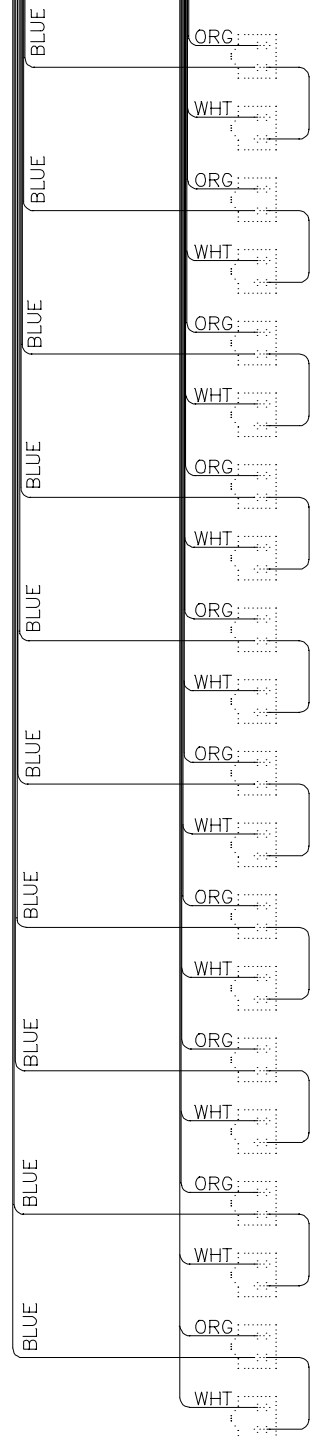

BLU
15112
(10 PLACES)

