

TO LEFT DOOR
26763-01

756V LEFT MODULE 26772-01, REV A

TO RIGHT MODULE
26454-01

TO RIGHT MODULE
26766-01

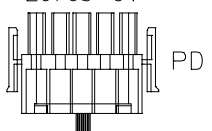

TO LEFT DOOR
26076-01

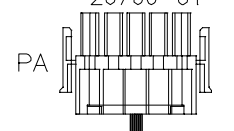
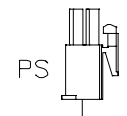
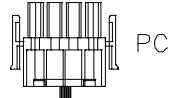

TO RIGHT MODULE
26080-01

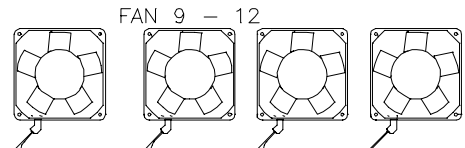

24105-05

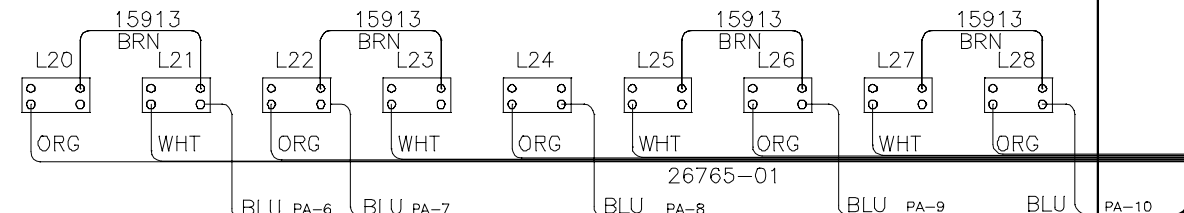
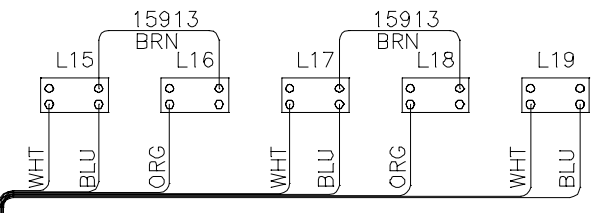

*1

*2

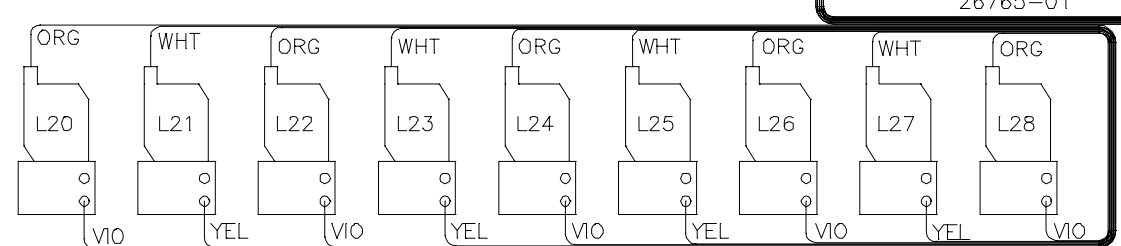
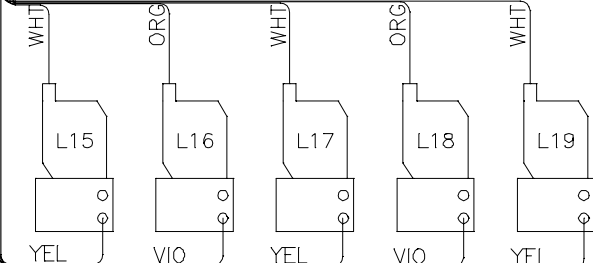
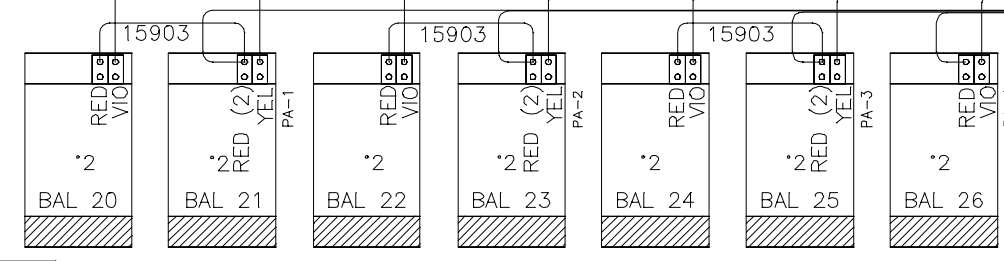
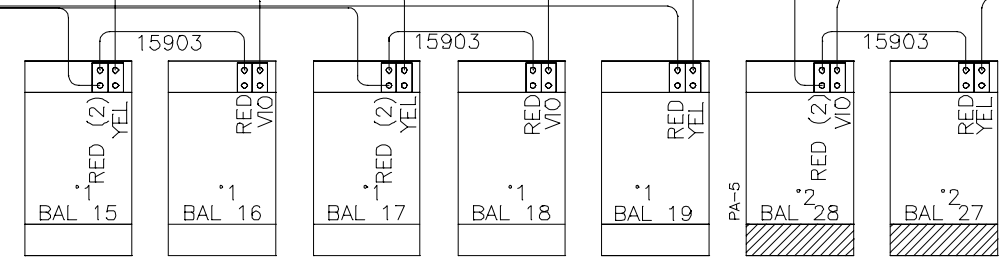
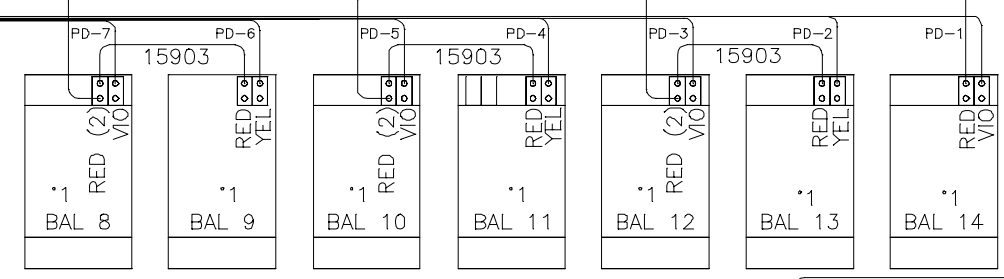
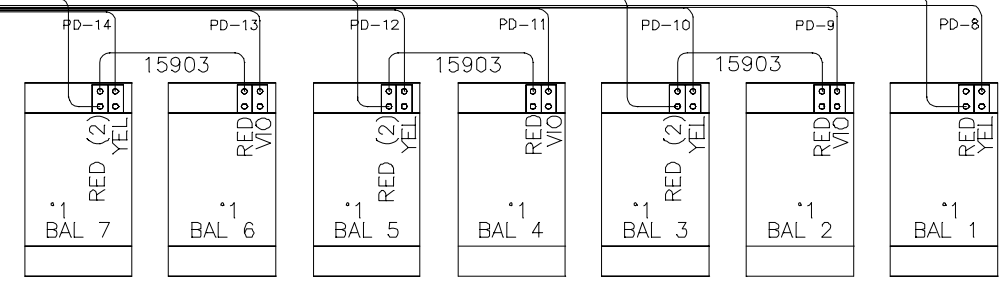
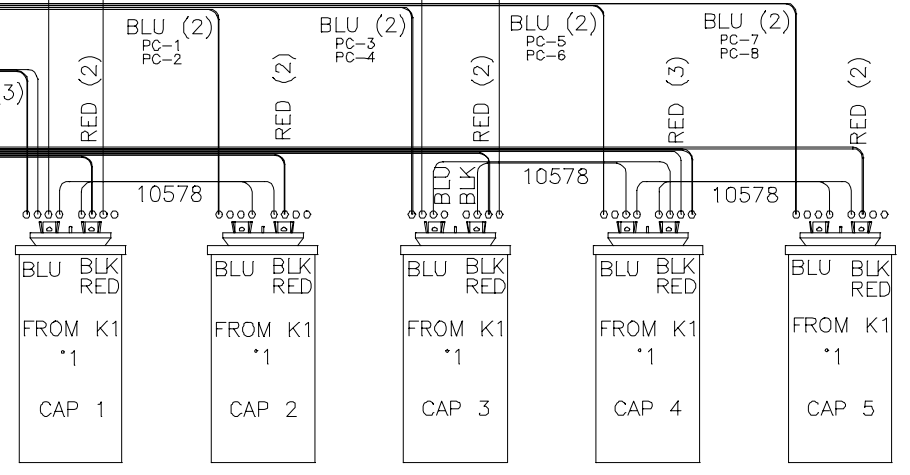
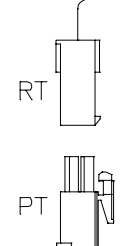
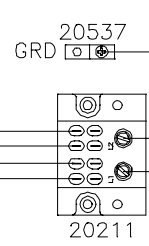
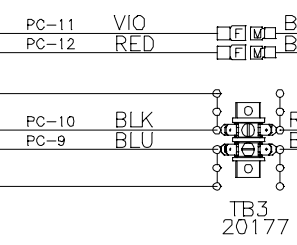

26764-01

26076-01

26763-01

26767-01

26766-01

26765-01

756V
LEFT DOOR
VIEWED FROM LAMP SIDE
26670-01, REV A

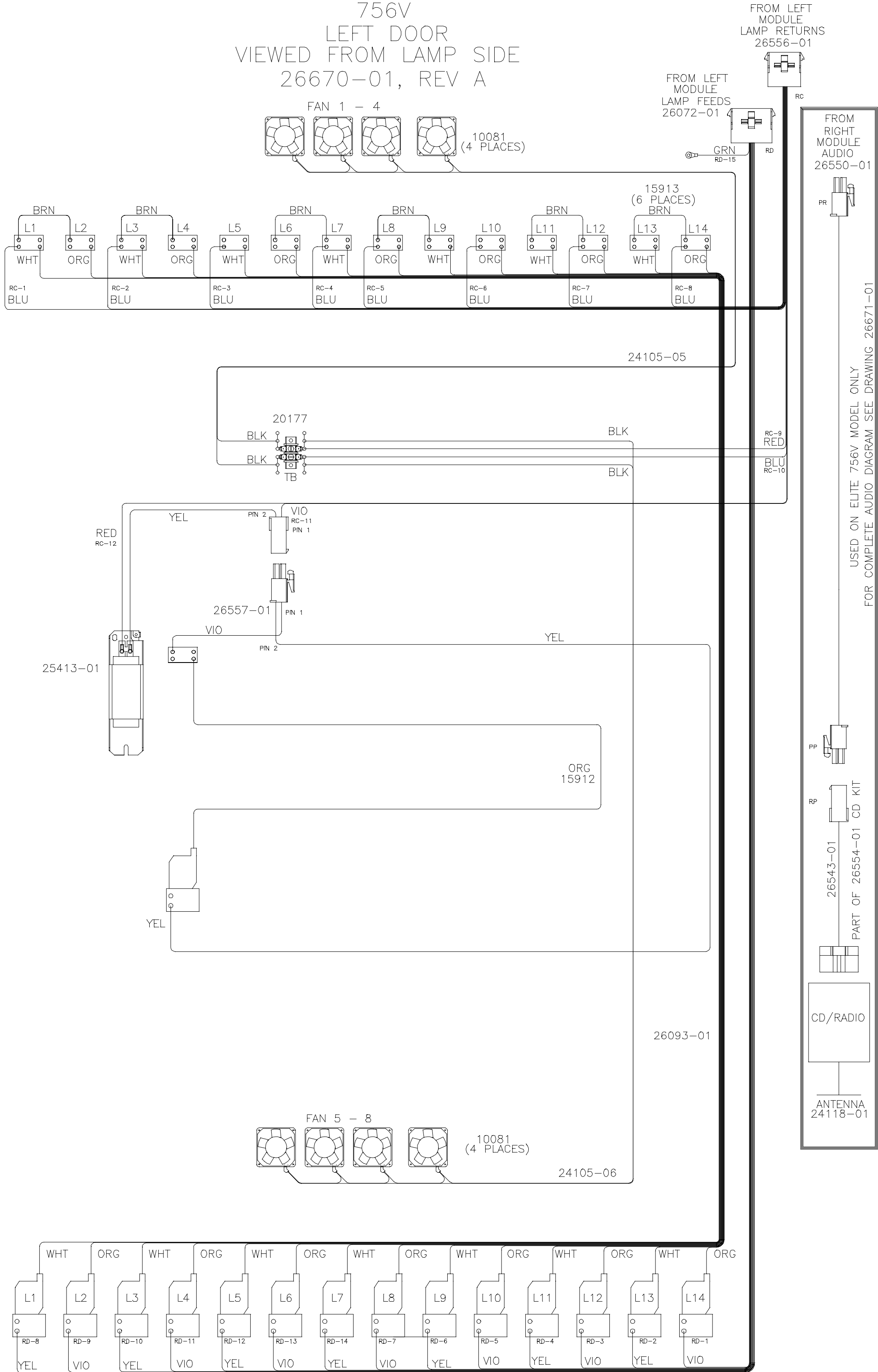

USED ON ELITE 756V MODEL ONLY
FOR COMPLETE AUDIO DIAGRAM SEE DRAWING 26671-01

FROM LEFT MODULE
LAMP RETURNS
26556-01

756V
RIGHT DOOR
VIEWED FROM LAMP SIDE
26670-01, REV A

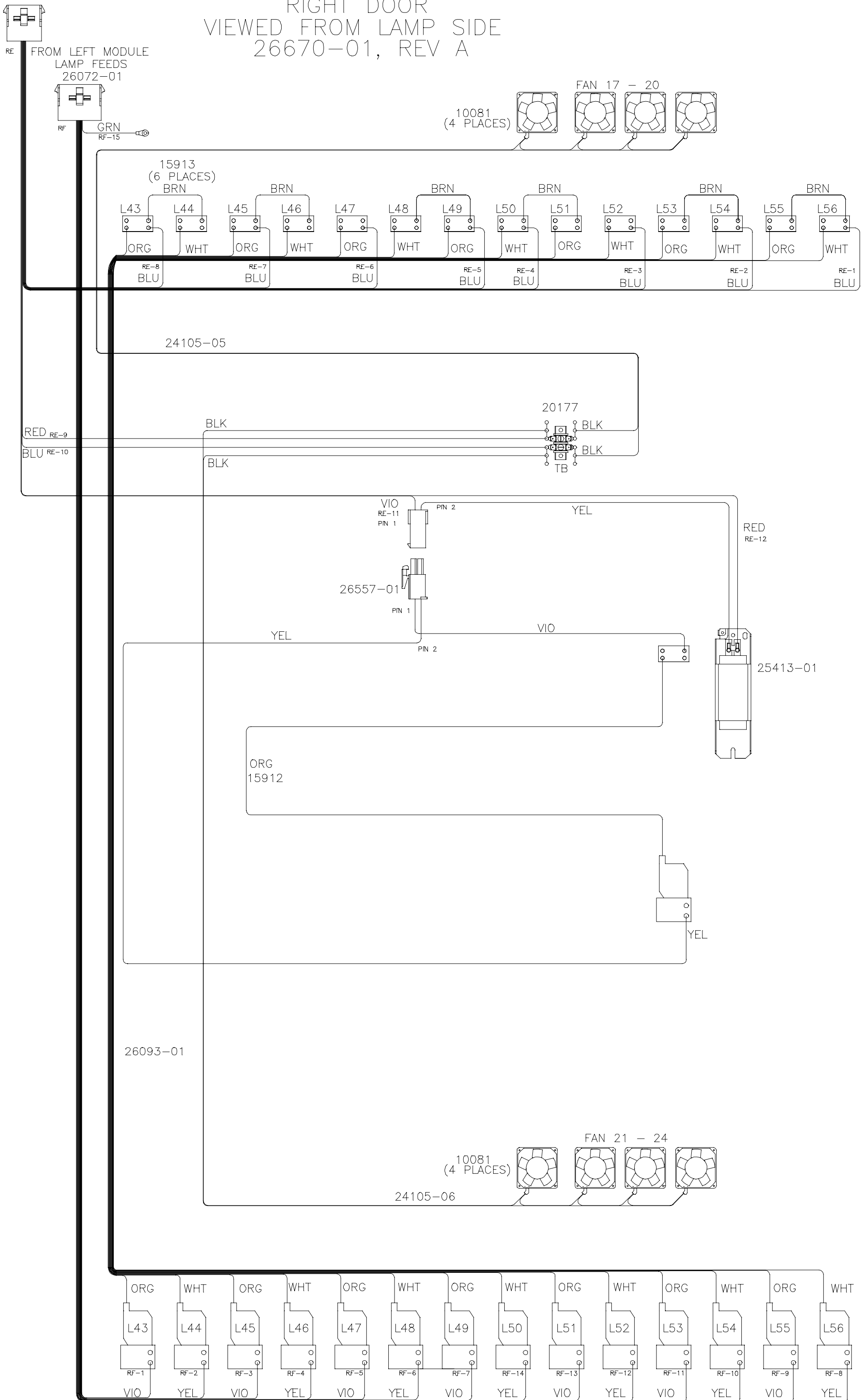

AUDIO SYSTEM FOR ELITE 756V MODELS

26671-01, REV A

WARNING: ALTERING THE DESIGN, TIMER SYSTEM, OR WIRING FROM THAT SHOWN HEREIN, WILL VOID THE WARRANTY, AND MAY RESULT IN A VIOLATION OF FEDERAL LAW.

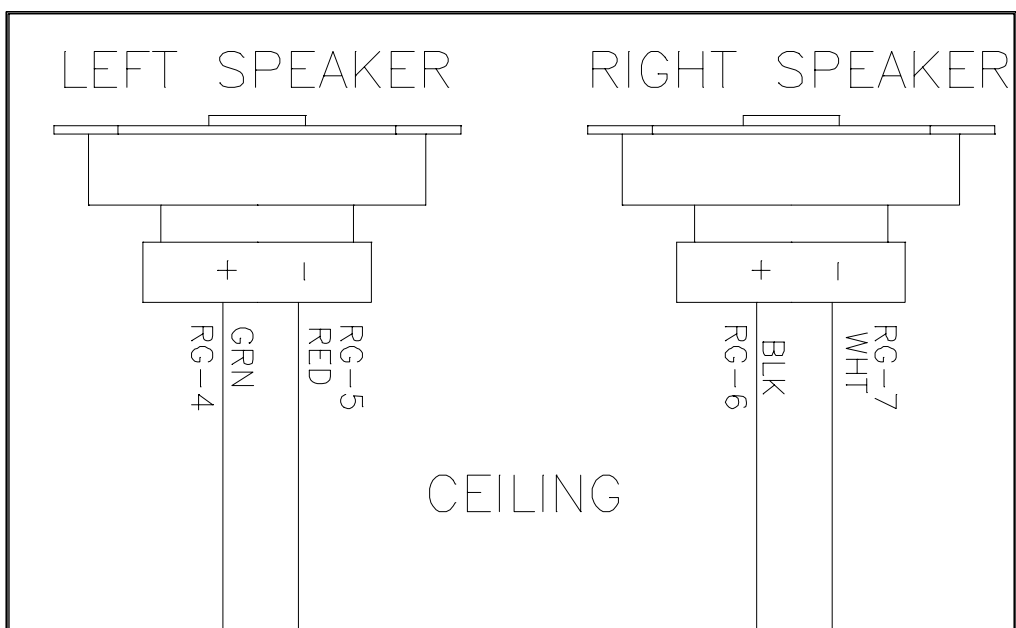

FUNCTION	RP	PP/PR/RR
BATTERY -	BLK-1	BLK-1
BATTERY +	YEL-4	YEL-4
ACCESSORY	RED-4	
SPKR L. REAR	GRN/BLK-5	
SPKR L. REAR	GRN-9	
SPKR R. REAR	VIO/BLK-6	
SPKR R. REAR	VIO-10	
SPKR R. FRONT	GRY/BLK-7	RED-7
SPKR R. FRONT	GRY-11	GRN-11
SPKR L. FRONT	WHT/BLK-8	WHT-8
SPKR L. FRONT	WHT-12	BLK-12

