

TO LEFT DOOR

TO RIGHT MODULE

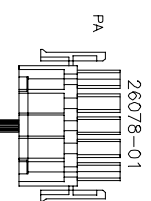
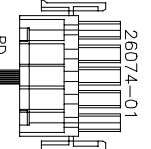

# SUNSCAPE 756V LEFT MODULE 26482-01, REV A

TO RIGHT DOOR

26076-01

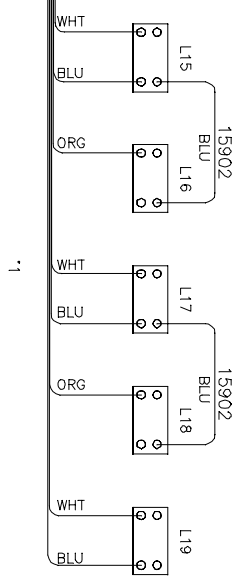
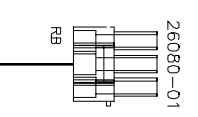
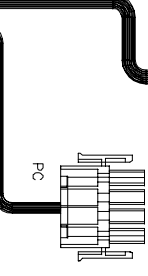

1

24105-05

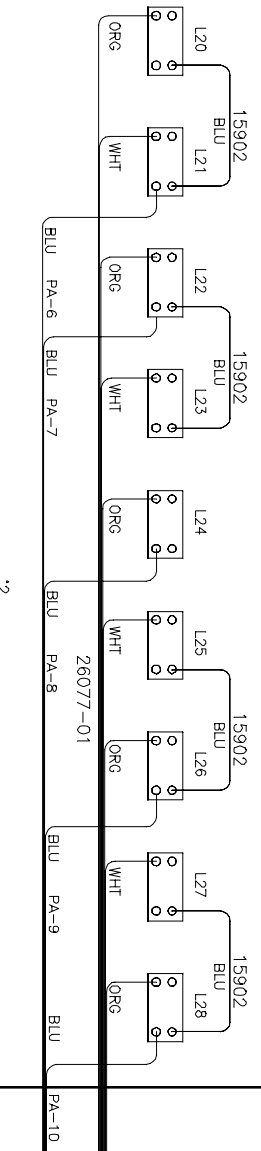
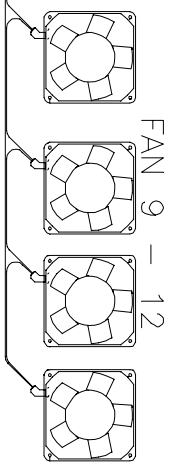

2

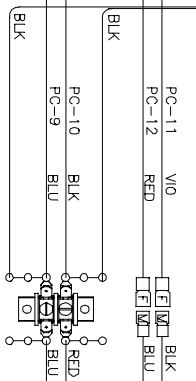

TR3  
20177

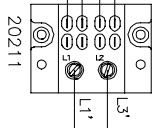
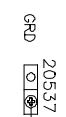

20211

26075-01

26076-01

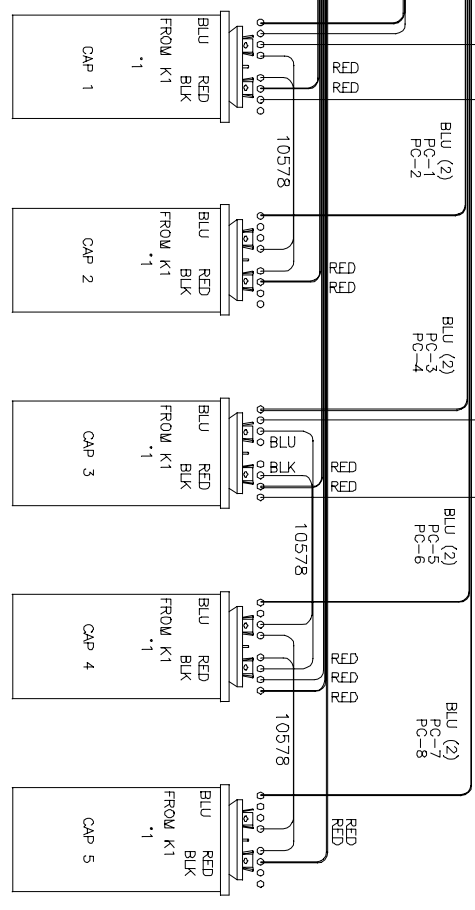

26074-01

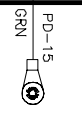

26082-01

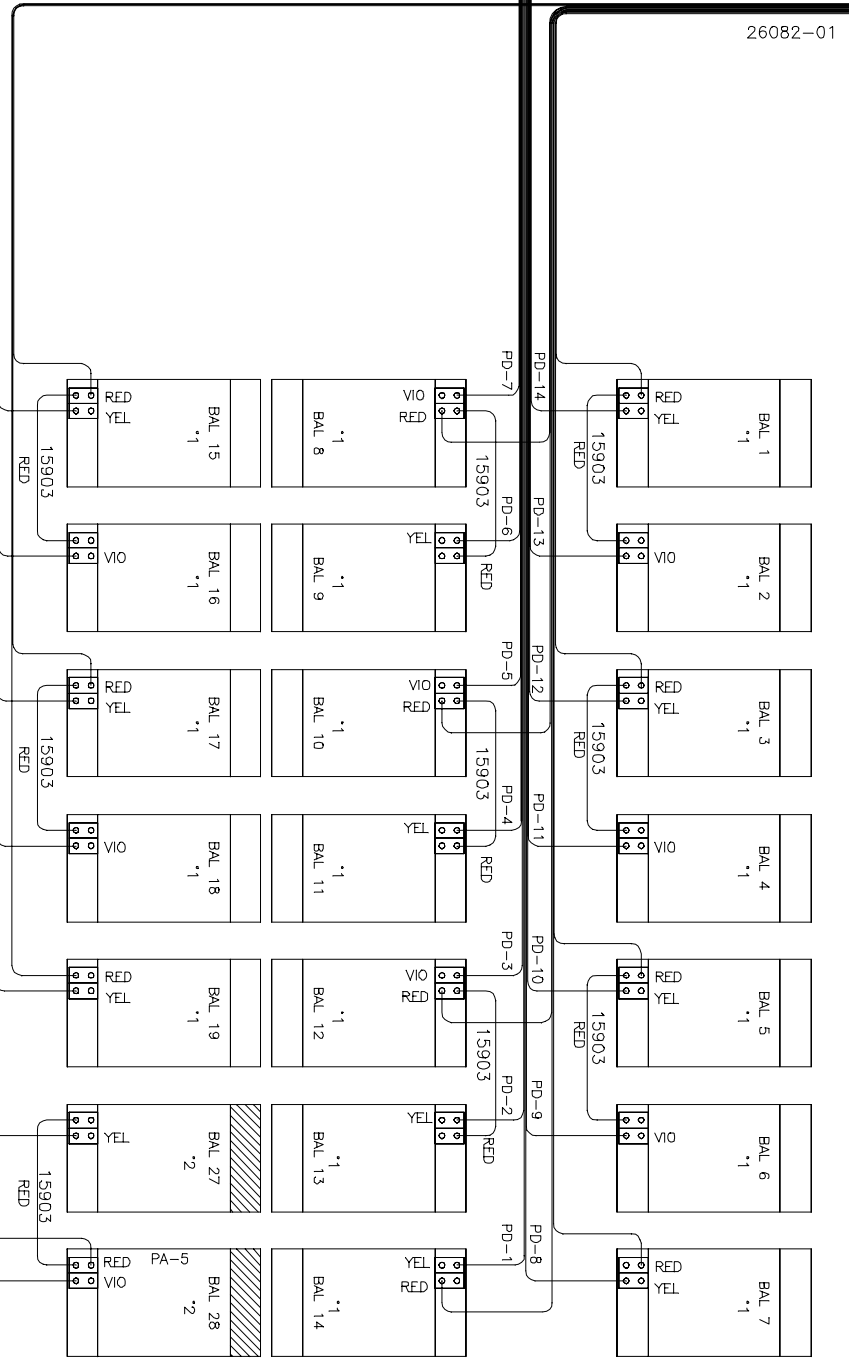

26078-01

26077-01

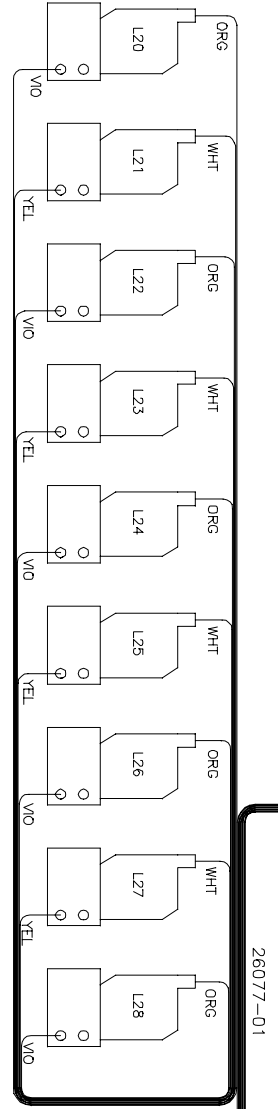
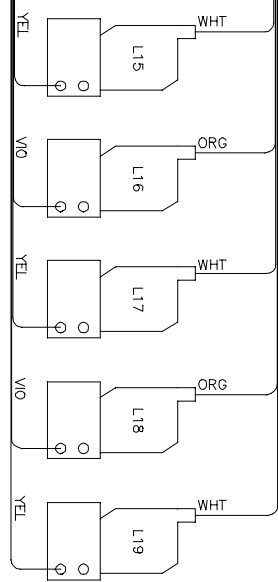

# SUNSCAPE 756V LEFT MODULE 26482-01, REV A

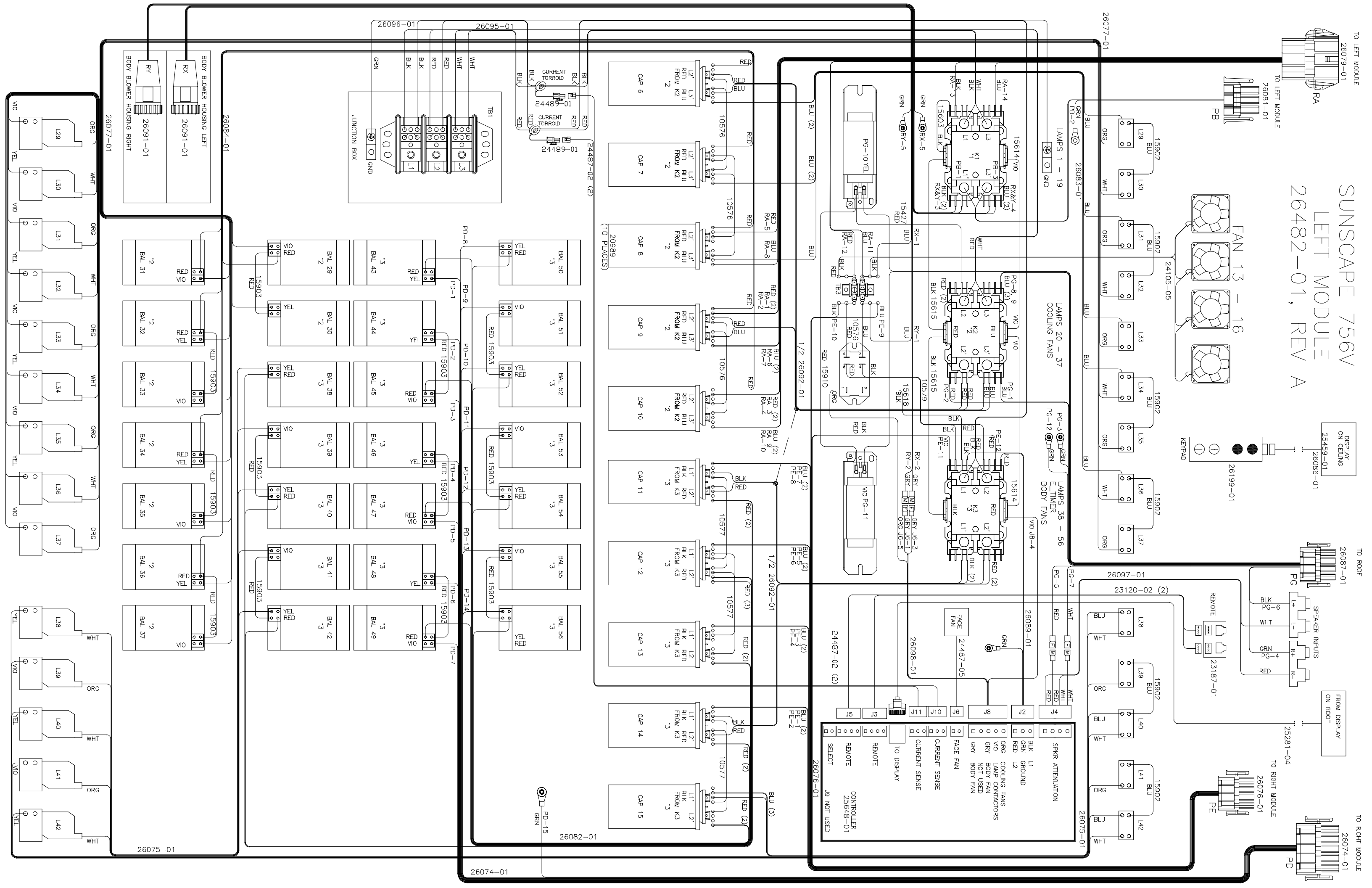

TO LEFT MODULE  
26079-01

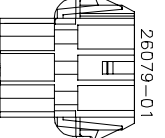

TO ROOF  
26087-01

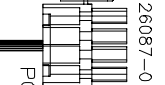

TO RIGHT MODULE  
26074-01

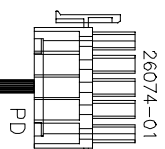

TO LEFT MODULE  
26081-01

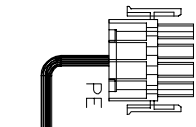
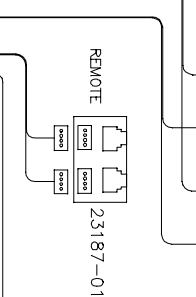
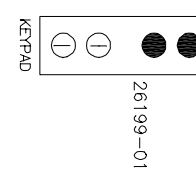
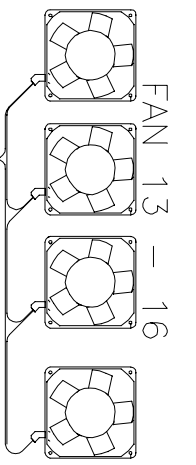
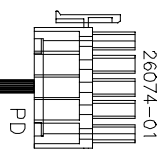
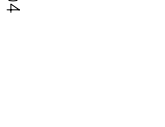
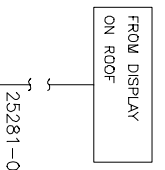
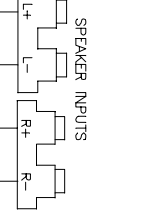
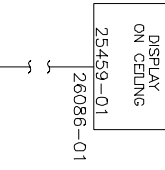
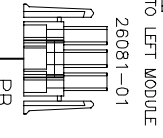

26077-01

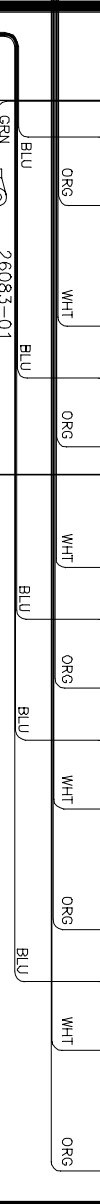

26097-01



26083-01



26092-01

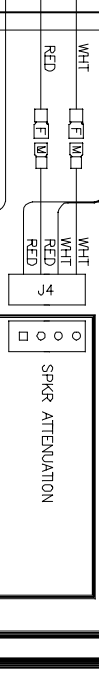

26092-01

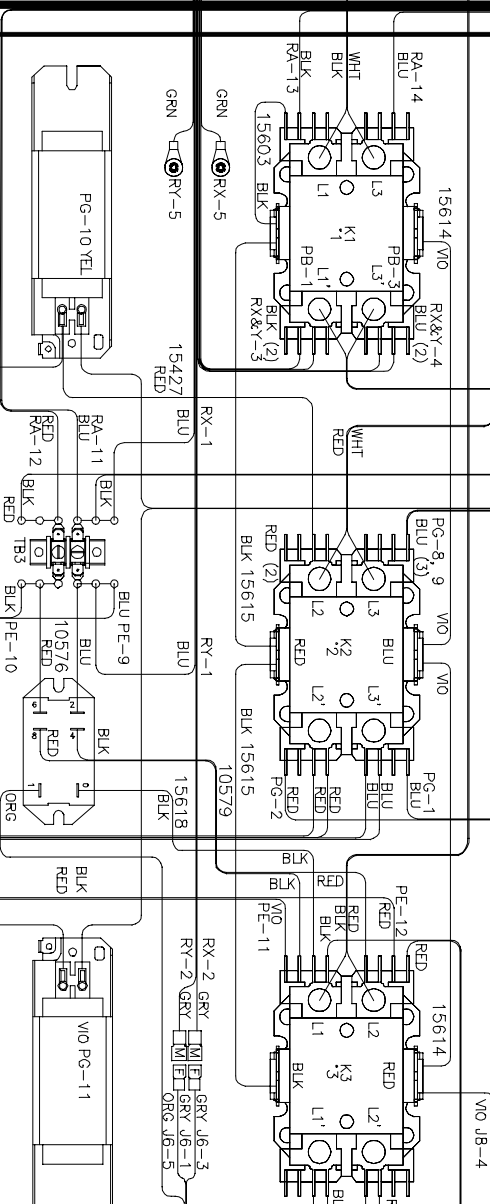

26098-01

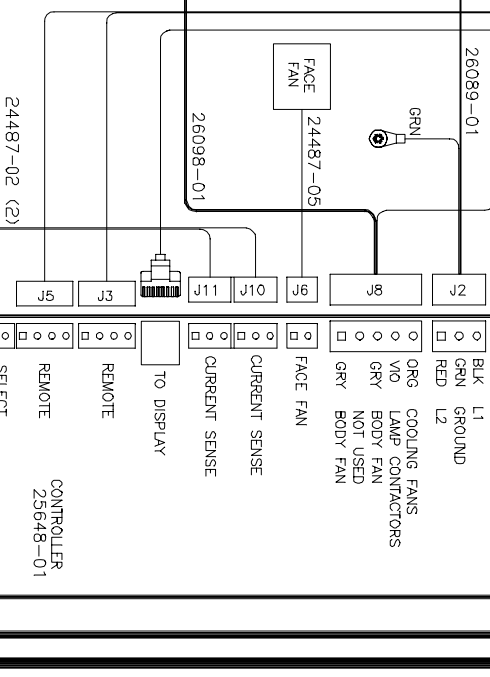

26092-01

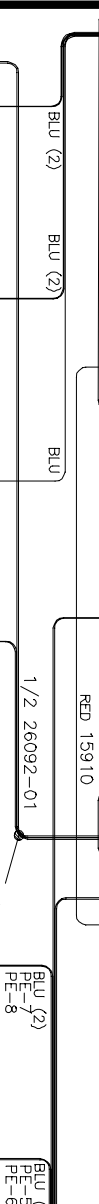

26092-01

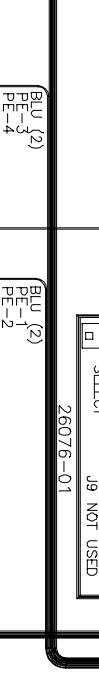

26092-01

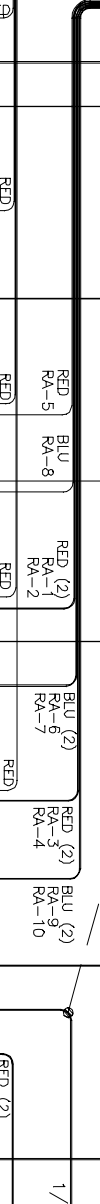

26092-01

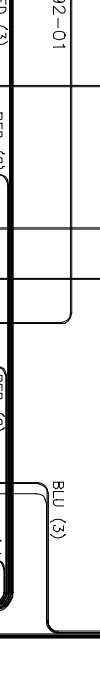

26092-01

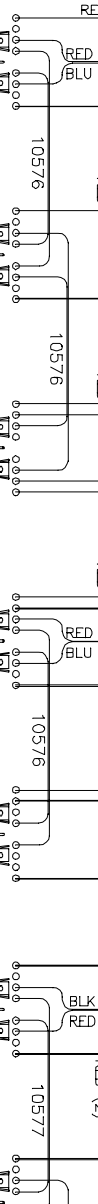

26092-01

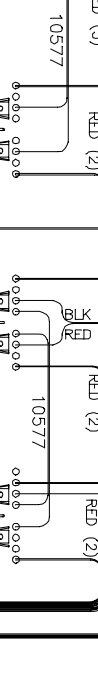

26092-01

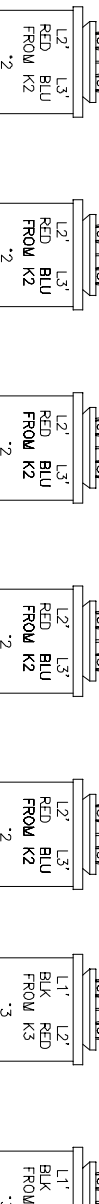

26092-01

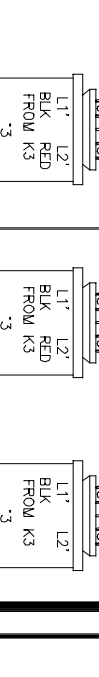

26092-01

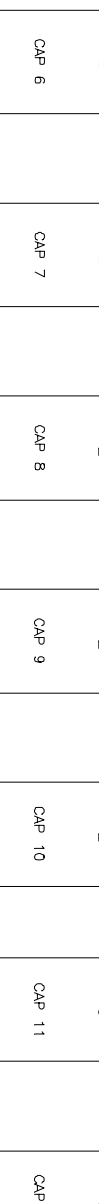

26092-01

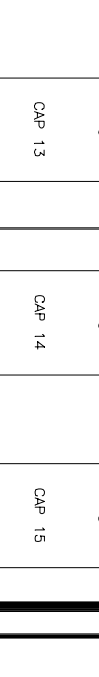

26092-01

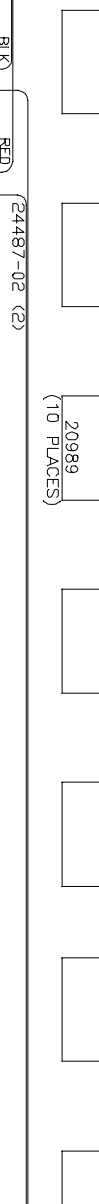

26092-01



26092-01

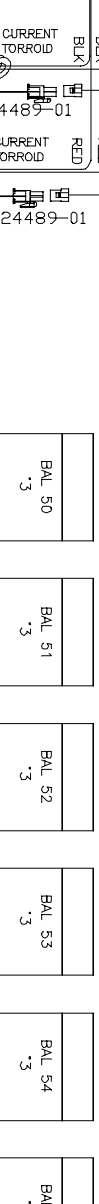

26092-01



26092-01

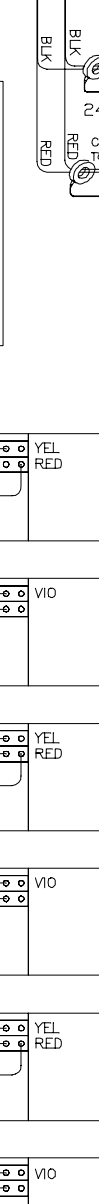

26092-01



26092-01

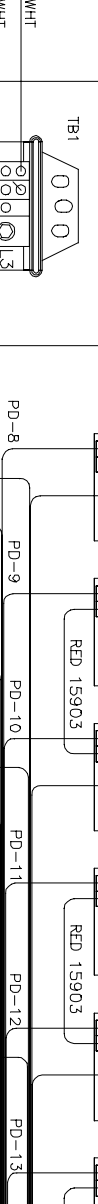

26092-01



26092-01

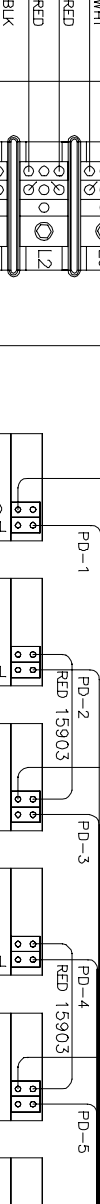

26092-01



26092-01

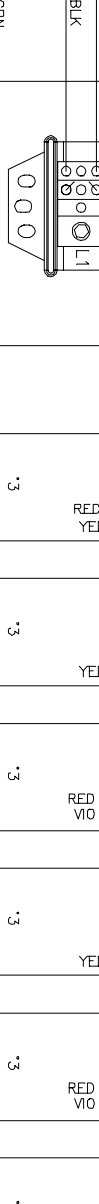

26092-01

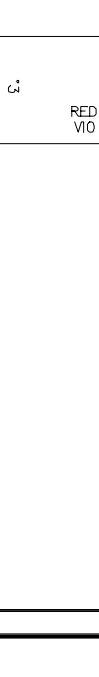

26092-01



26092-01



26092-01

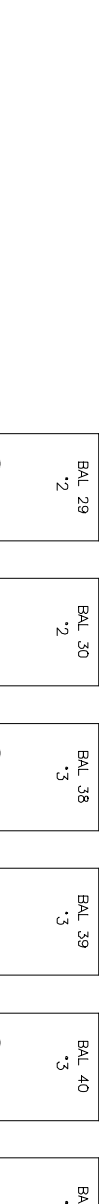

26092-01



26092-01

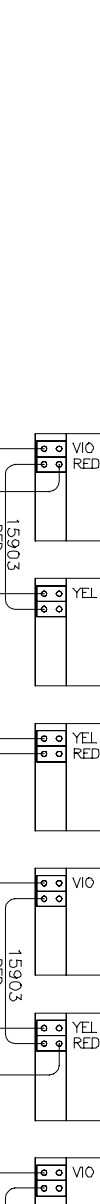

26092-01



26092-01

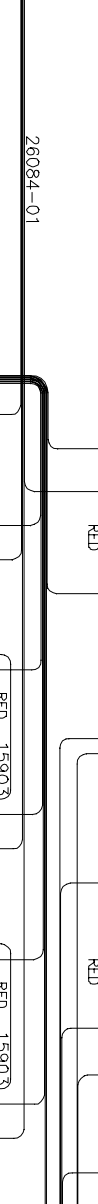

26092-01

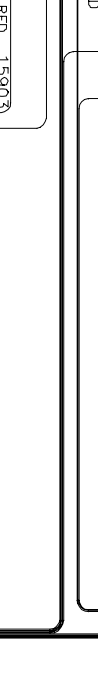

26092-01

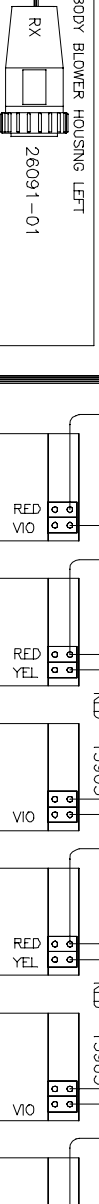

26092-01



26092-01

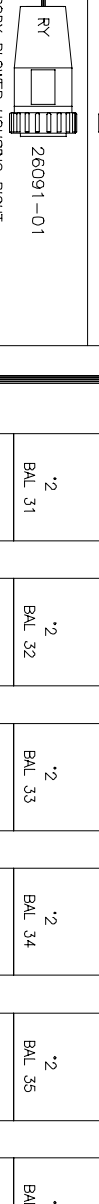

26092-01



26092-01

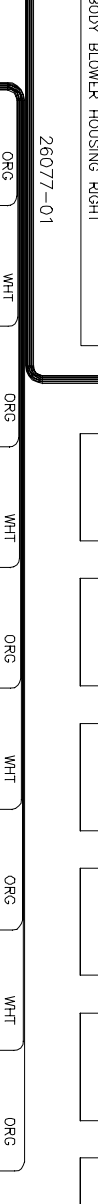

26092-01



26092-01



26092-01

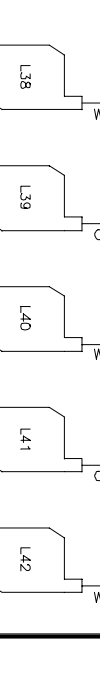

26092-01

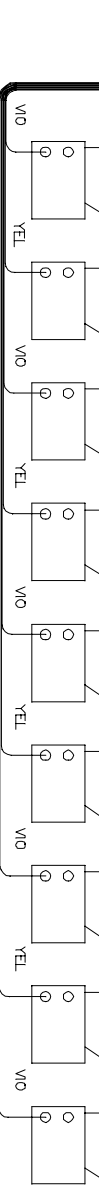

26092-01

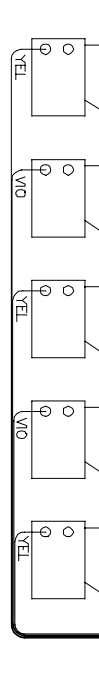

SUNSCAPE 756V  
LEFT DOOR  
26281-01, REV A

FROM LEFT MODULE  
LAMP RETURNS

26073-01

FROM LEFT MODULE  
LAMP FEEDS

26072-01

FAN 1 - 4

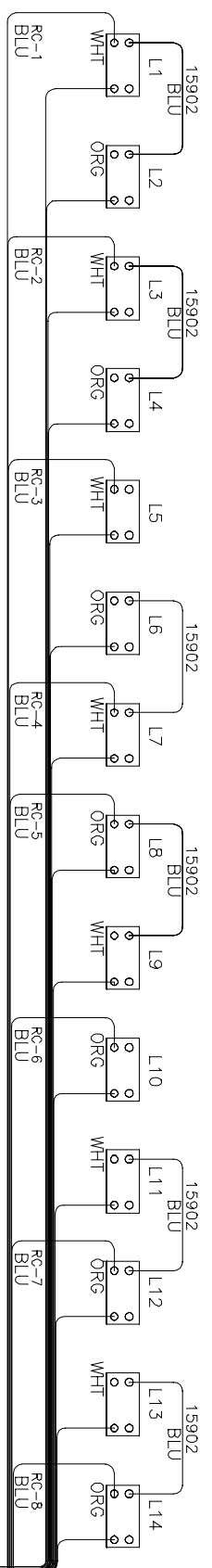
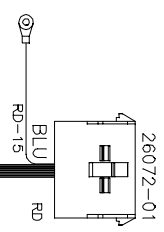
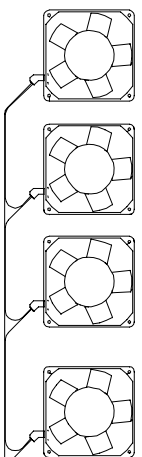

24105-05

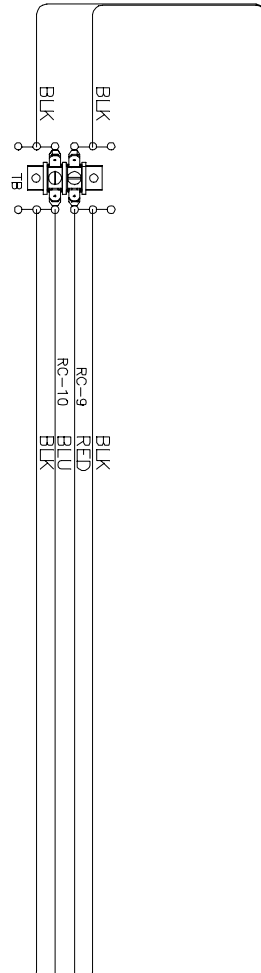

RED  
RC-12

VIO  
RC-11

YEL 15908  
ORG 15909

24105-06

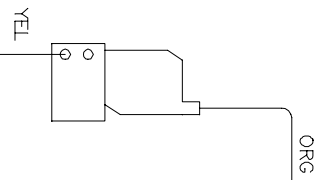
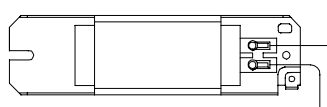

26093-01

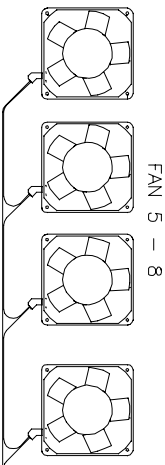

FAN 5 - 8

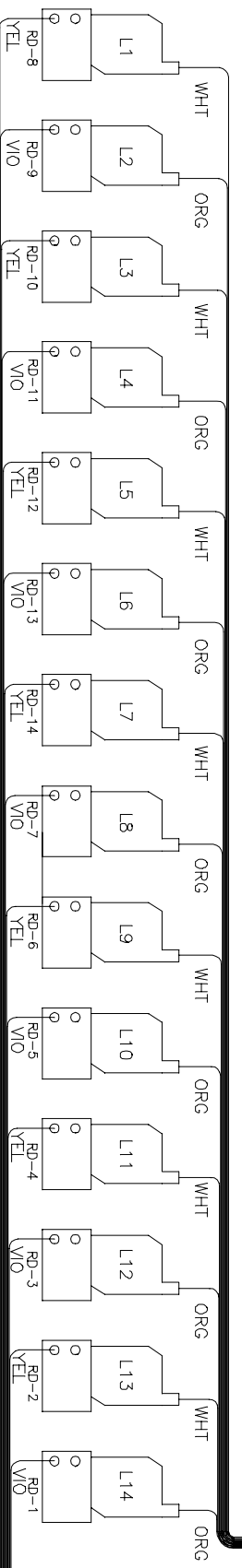
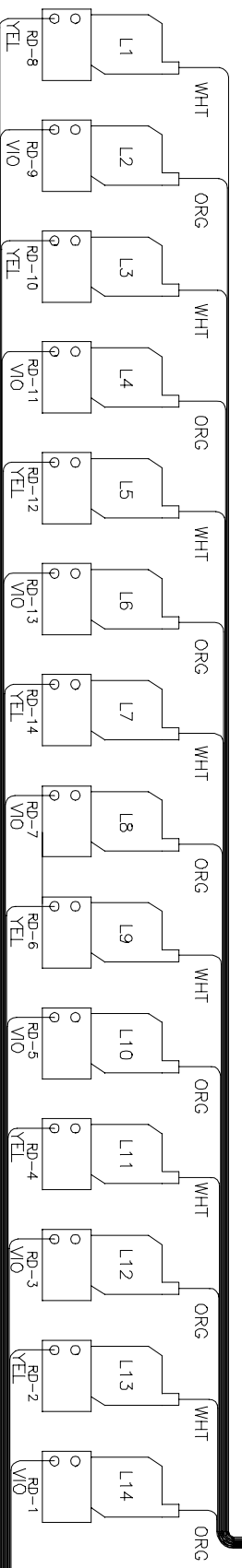

# SUNSCAPE 756V RIGHT DOOR 26281-01, REV A

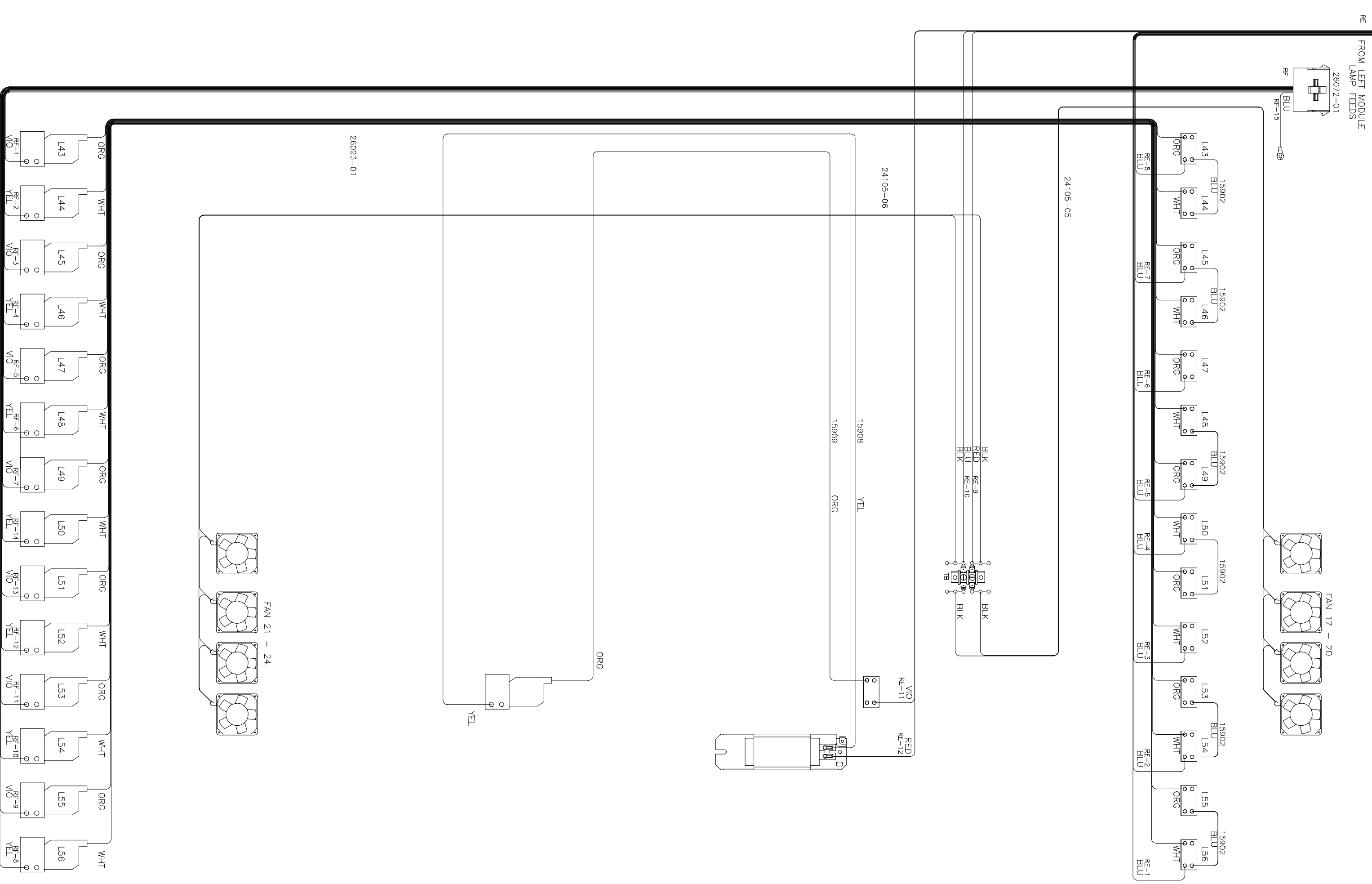

WARNING: ALTERING THE DESIGN, TIMER SYSTEM, OR WIRING FROM THAT SHOWN HEREIN, WILL VOID THE WARRANTY, AND MAY RESULT IN A VIOLATION OF FEDERAL LAW.

# INTERCONNECT DIAGRAM 756V 26282-01, REV A

SZ067-01/SZ078-01		
PIN	COLOR	FUNCTION
1	BLACK	BODY FAN RTN
2	GRAY	BODY FAN FEED
3	BLACK	HOUR COUNTER
4	BLUE	HOUR COUNTER
5	BLACK	R- SPKR
6	-	NOT USED
7	-	NOT USED
8	-	NOT USED
9	-	NOT USED

SZ071-01/SZ072-01		
PIN	COLOR	FUNCTION
1	BLUE	L1' FAN
2	BLACK	L2' FAN
3	GREEN	GROUND FAN
4	BLACK	R+ SPKR
5	BLACK	R- SPKR
6	BLACK	L+ SPKR
7	BLACK	L- SPKR
8	BLUE	FRONT LIGHT
9	BLACK	REAR LIGHT
10	YELLOW	REAR LIGHT
11	VIOLET	FRONT LIGHT
12	GREEN	GROUND

