

26293-01, REV A
ZX32 NO FACE
CANOPY WIRING DIAGRAM

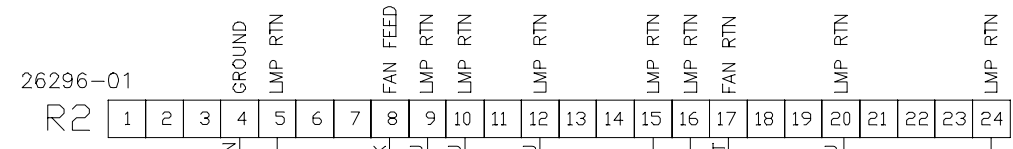

24496-01

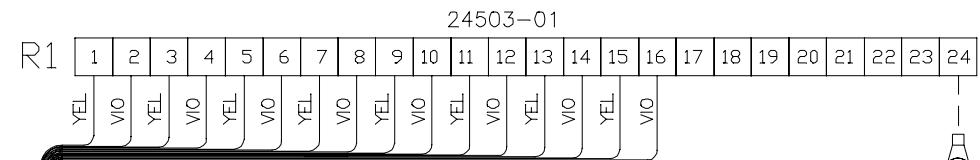
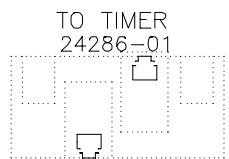
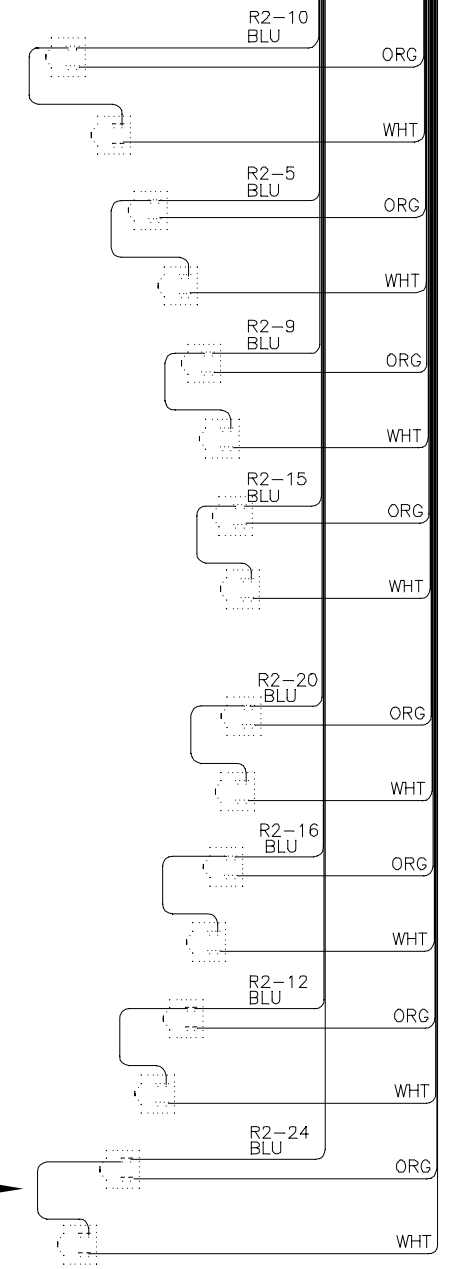
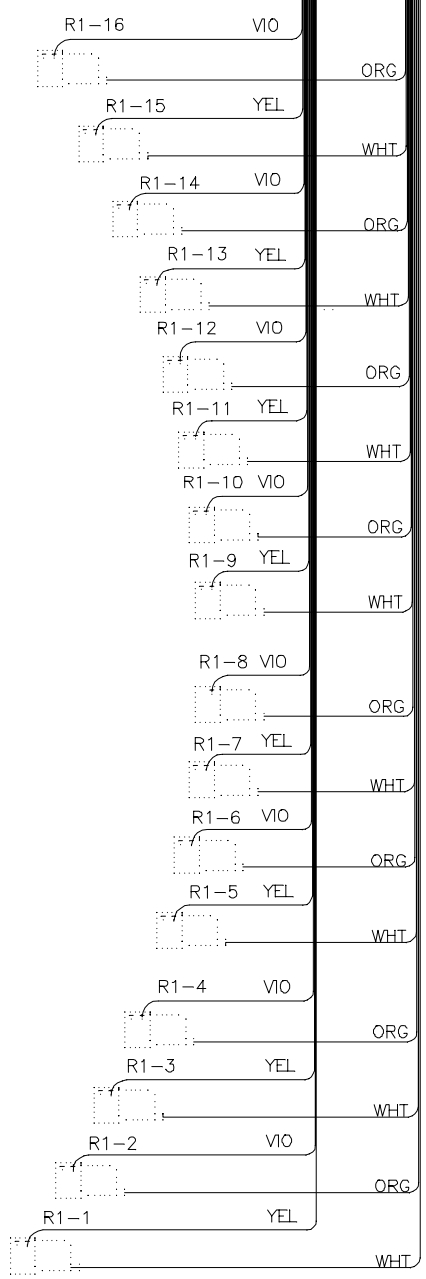
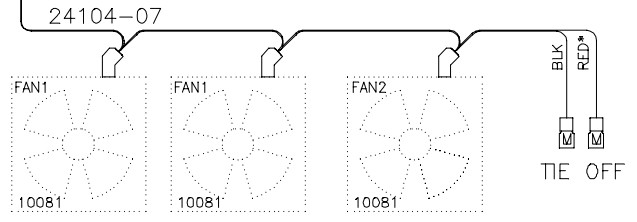

BLU (8 PLCS) 15902

BLU (8 PLCS) 15902

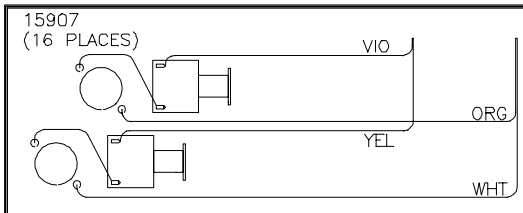

ALTERNATE LAMP HOLDER CONSTRUCTION
ZX32 NO FACE UNIT ONLY

24486-01



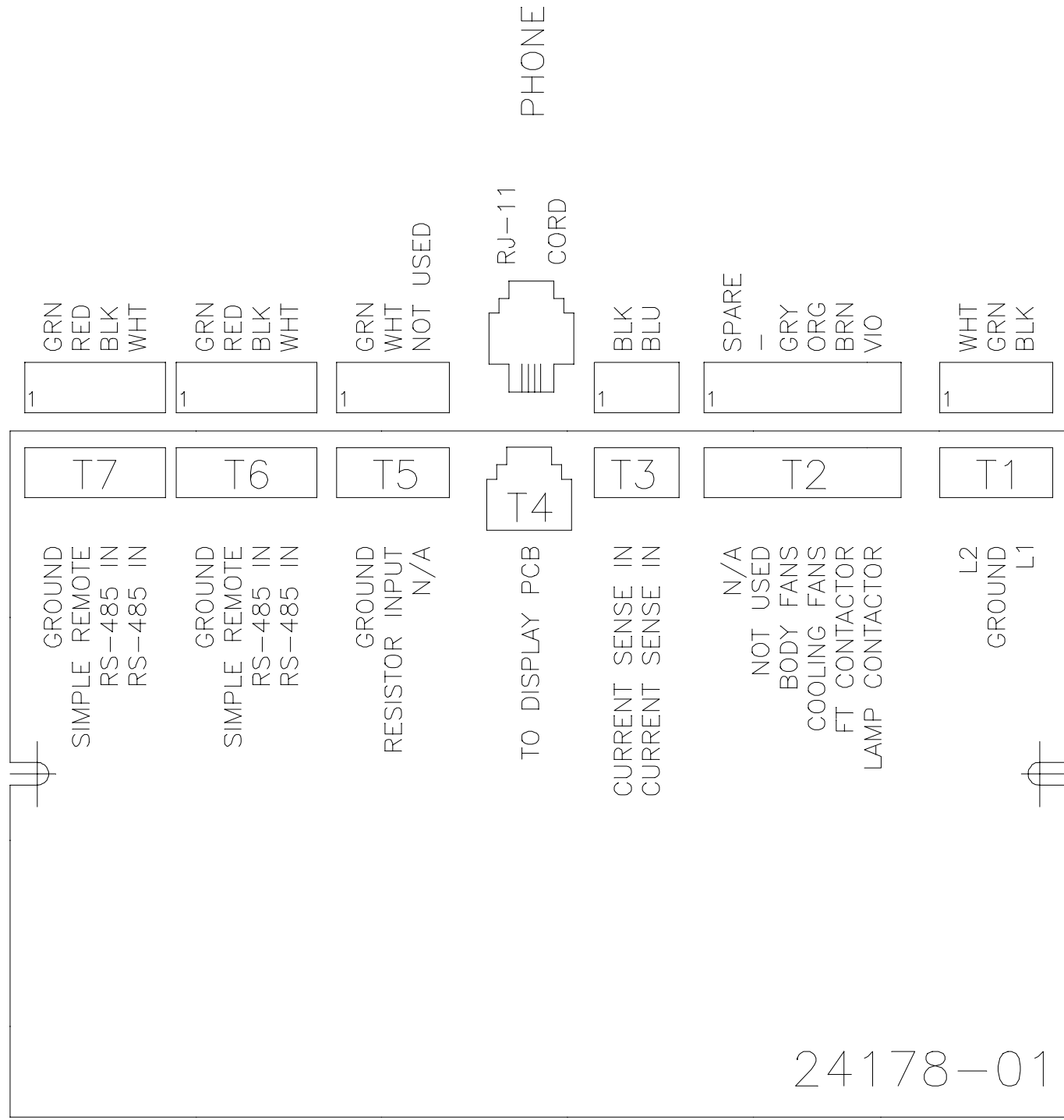

ELECTRONIC TIMER
 CONNECTOR DIAGRAM

PIN #	R3 FUNCTIONS
1	LAMP RETURN 1
2	GROUND
3	LAMP RETURN 2
4	FAN RETURN
5	BODY FAN CONTROL
6	FAN FEED
7	LAMP RETURN 3
8	BODY FAN RTN
9	LAMP RETURN 4

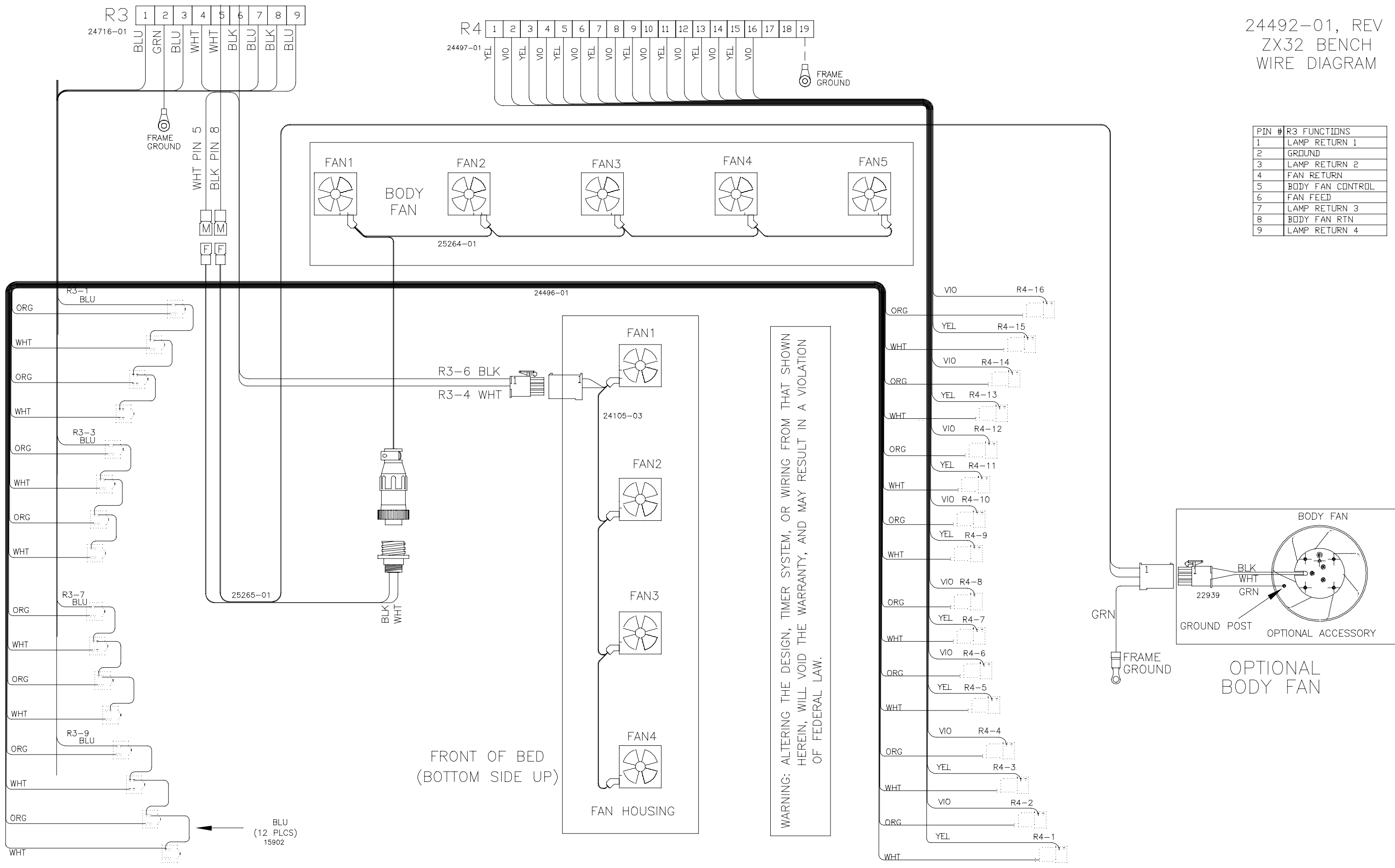

26294-01, REV A
 ZX32 TRAY '04
 BENCH SIDE
 WIRING DIAGRAM

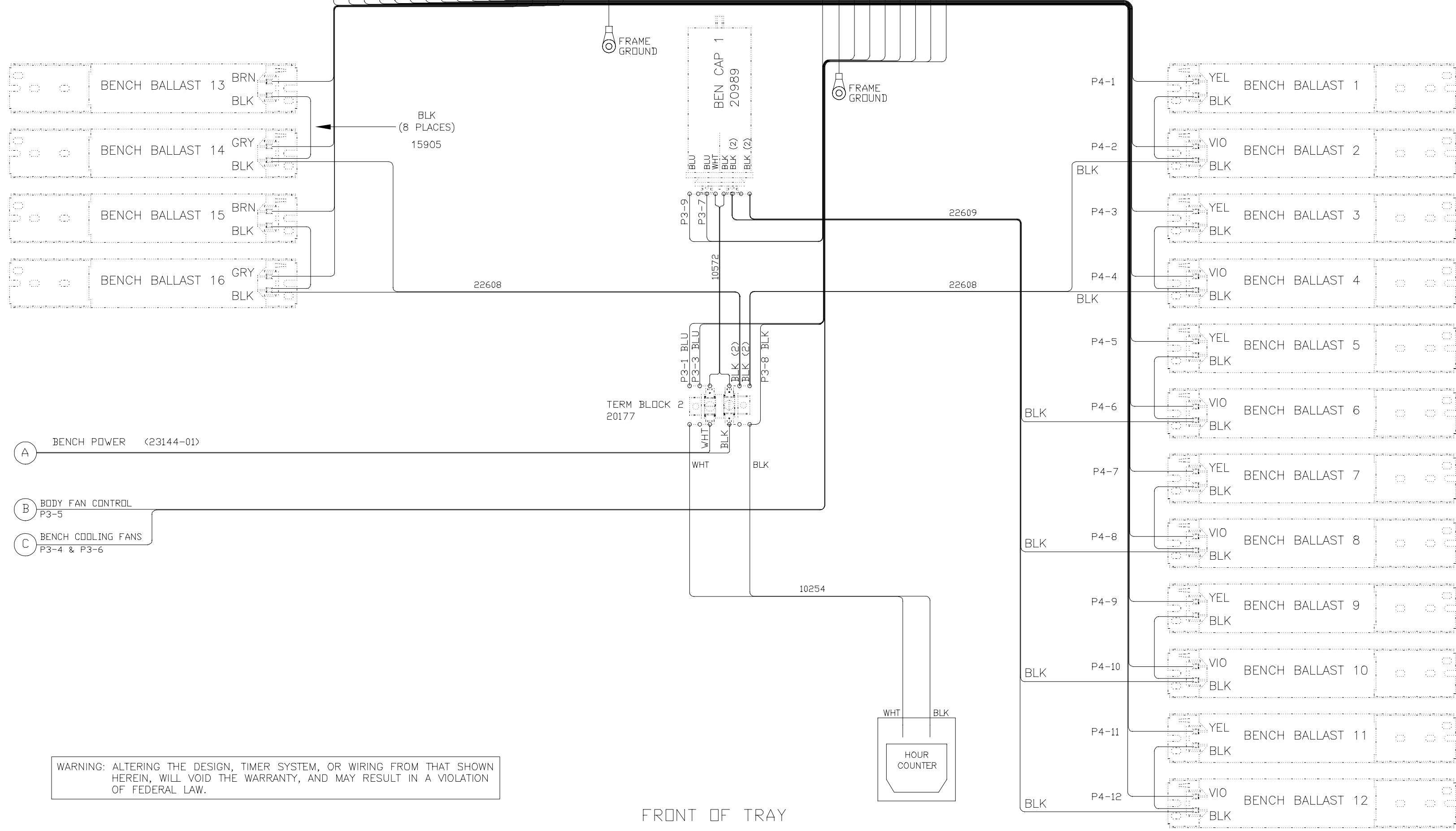
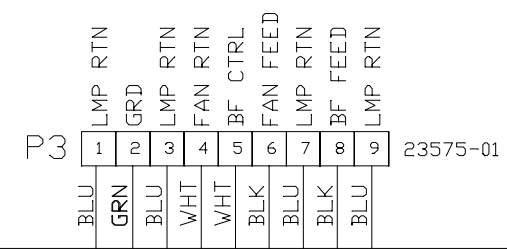
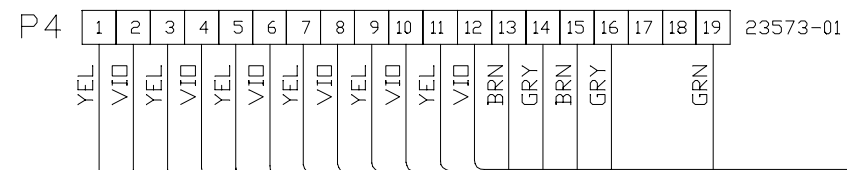

- (A) BENCH POWER (23144-01)
- (B) BODY FAN CONTROL P3-5
- (C) BENCH COOLING FANS P3-4 & P3-6

WARNING: ALTERING THE DESIGN, TIMER SYSTEM, OR WIRING FROM THAT SHOWN HEREIN, WILL VOID THE WARRANTY, AND MAY RESULT IN A VIOLATION OF FEDERAL LAW.

FRONT OF TRAY

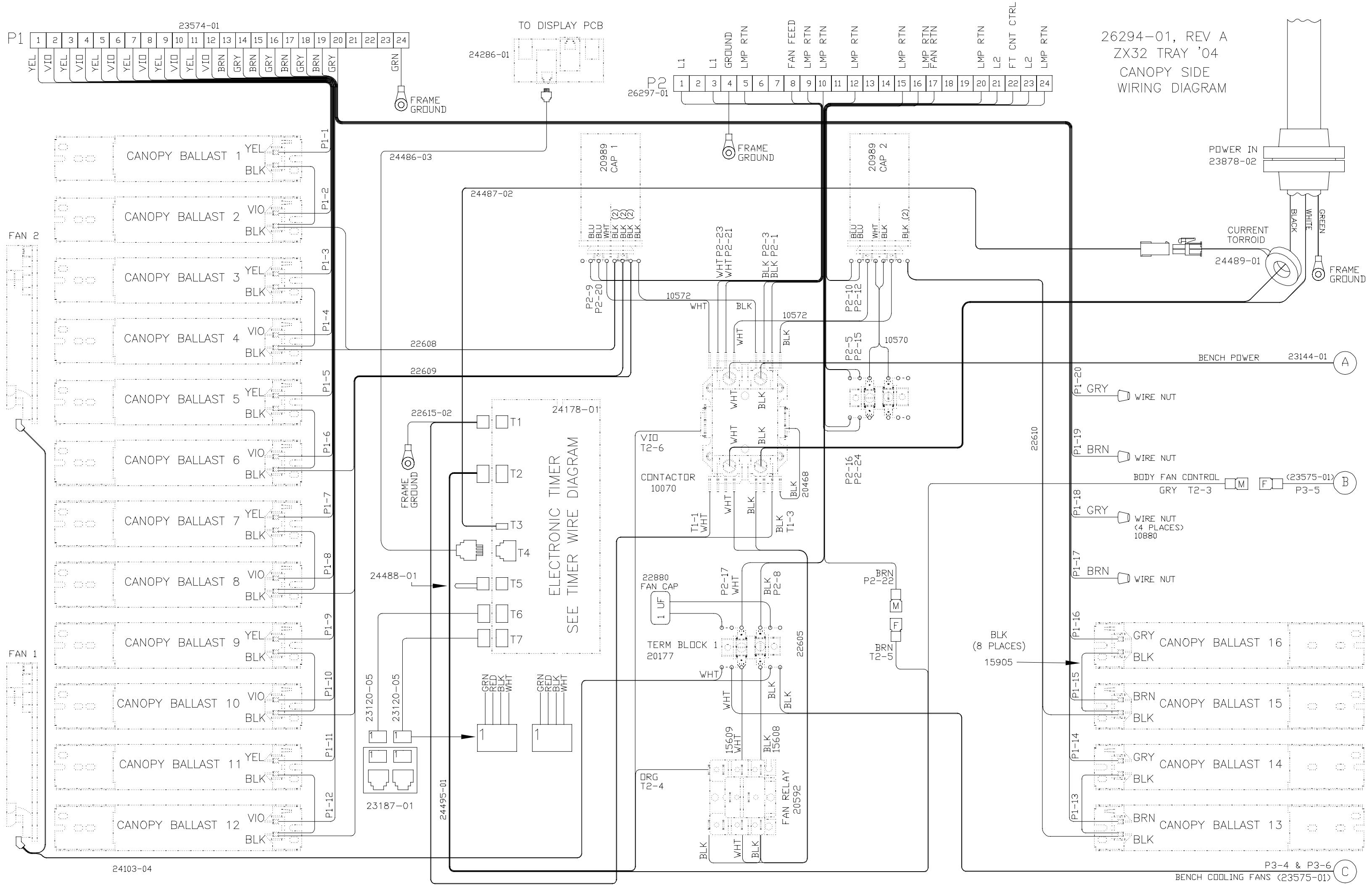

26294-01, REV A
ZX32 TRAY '04
CANOPY SIDE
WIRING DIAGRAM

ELECTRONIC TIMER
SEE TIMER WIRE DIAGRAM

P3-4 & P3-6
BENCH COOLING FANS (23575-01)

24103-04

(C)