

POWER INPUT

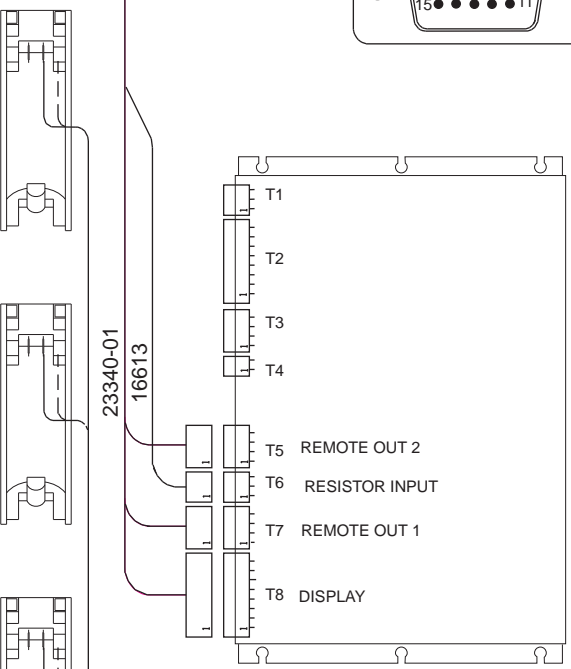

23374. REV. C
UPPER LEVEL TRAY
WIRE DIAGRAM

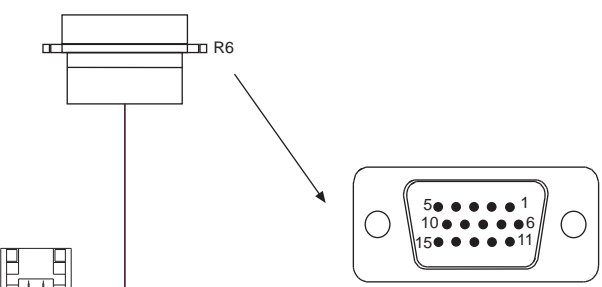
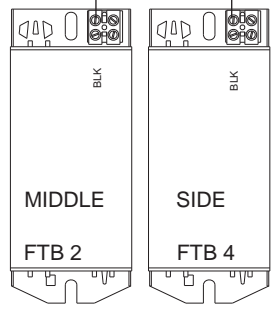
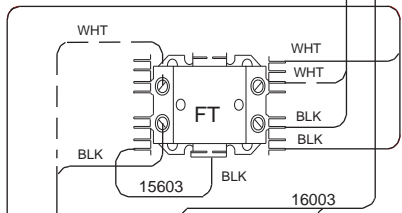
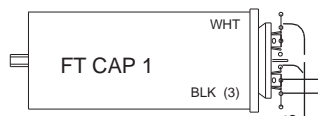
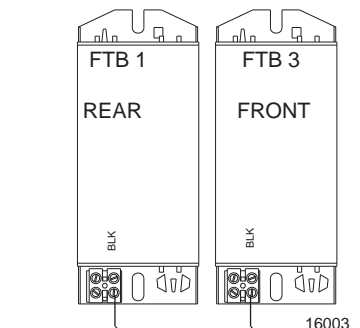

BLK
GRN
WHT

SHOULDER TANNER
(ST) RELAY

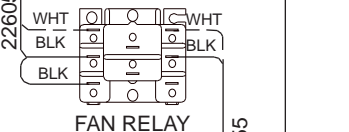
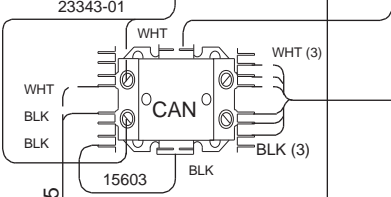
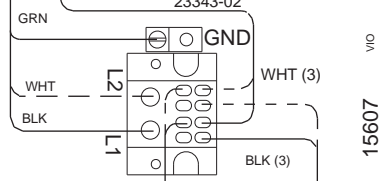
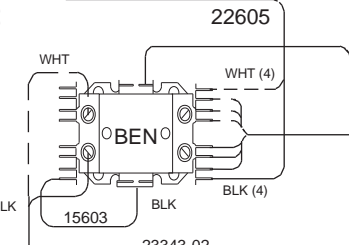
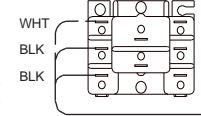

FAN RELAY

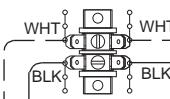

10873

23342-01

23347-01 (B)
23347-02 (C)
23347-03 (D)

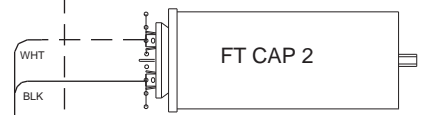
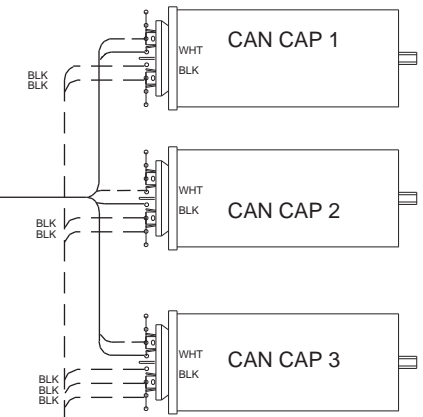
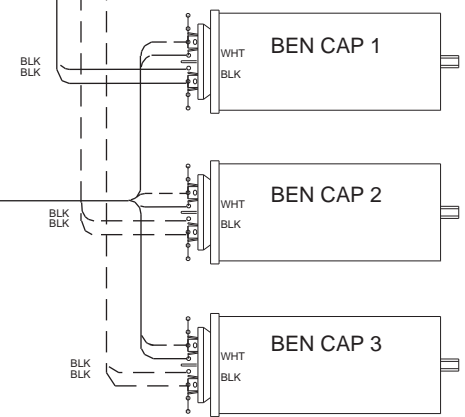

23346-01 (F)

P2
23198

TO BALLAST
24 - 26

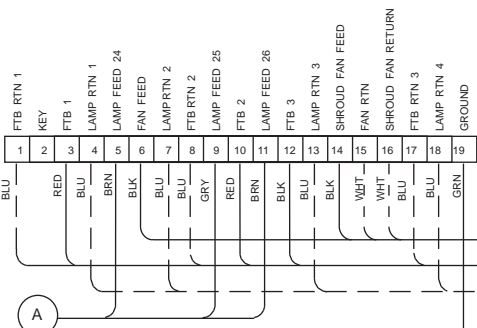
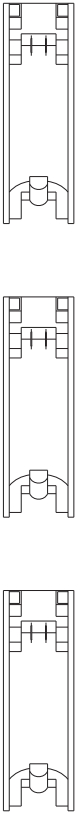

P4
23167

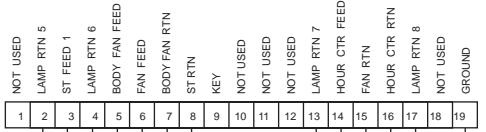

23199
P5

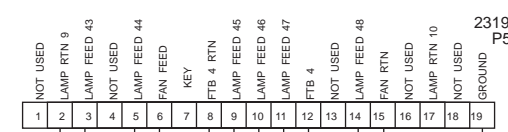

TO BALLAST
43 - 48

FRAME GROUND

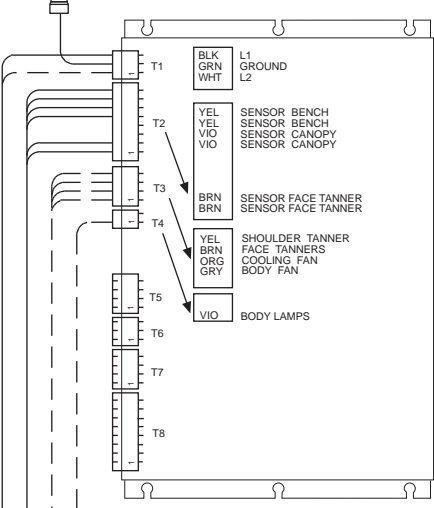

23374, REV C
UPPER LEVEL TRAY
WIRE DIAGRAM

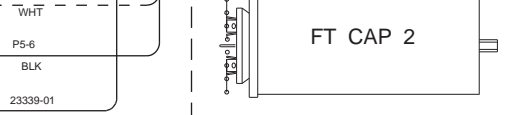
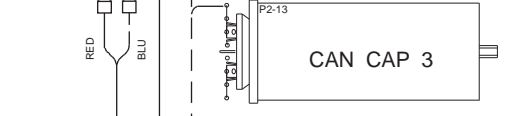
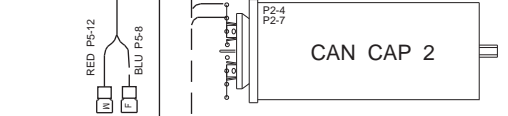
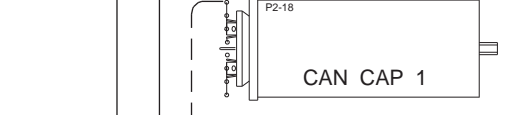
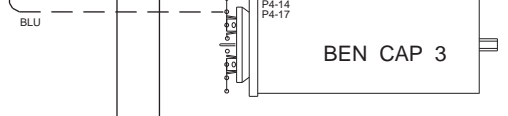
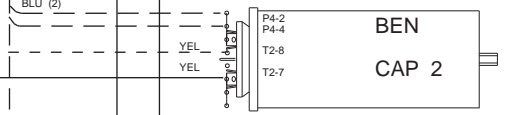
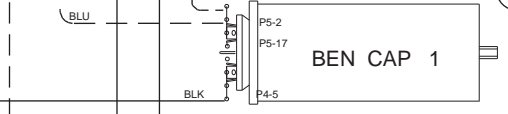
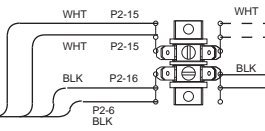
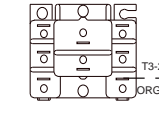
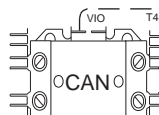
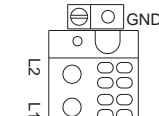
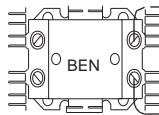
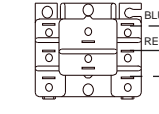
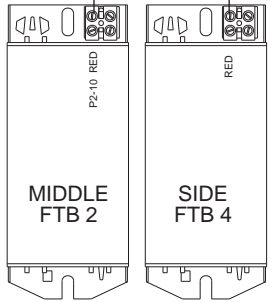
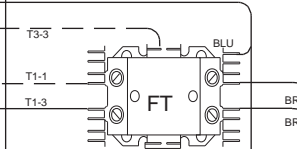
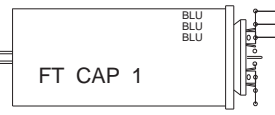
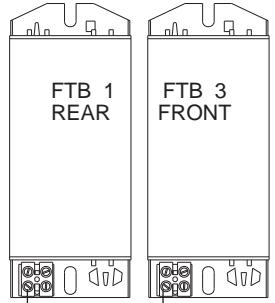

23338-01
23337-01
23336-01
23335-01

WARNING: ALTERING THE DESIGN, TIMER SYSTEM OR WIRING FROM THAT SHOWN HEREIN, WILL VOID THE WARRANTY, AND MAY RESULT IN A VIOLATION OF FEDERAL LAW.

23196-01

P1



23195-01

P3



FRAME GROUND

FRAME GROUND

23605, REV. A
STARPOWER TRAY BOTTOM
WIRE DIAGRAM

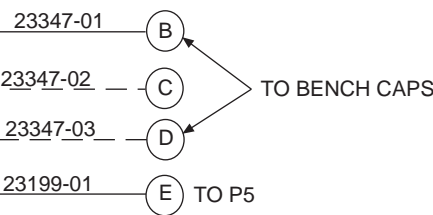
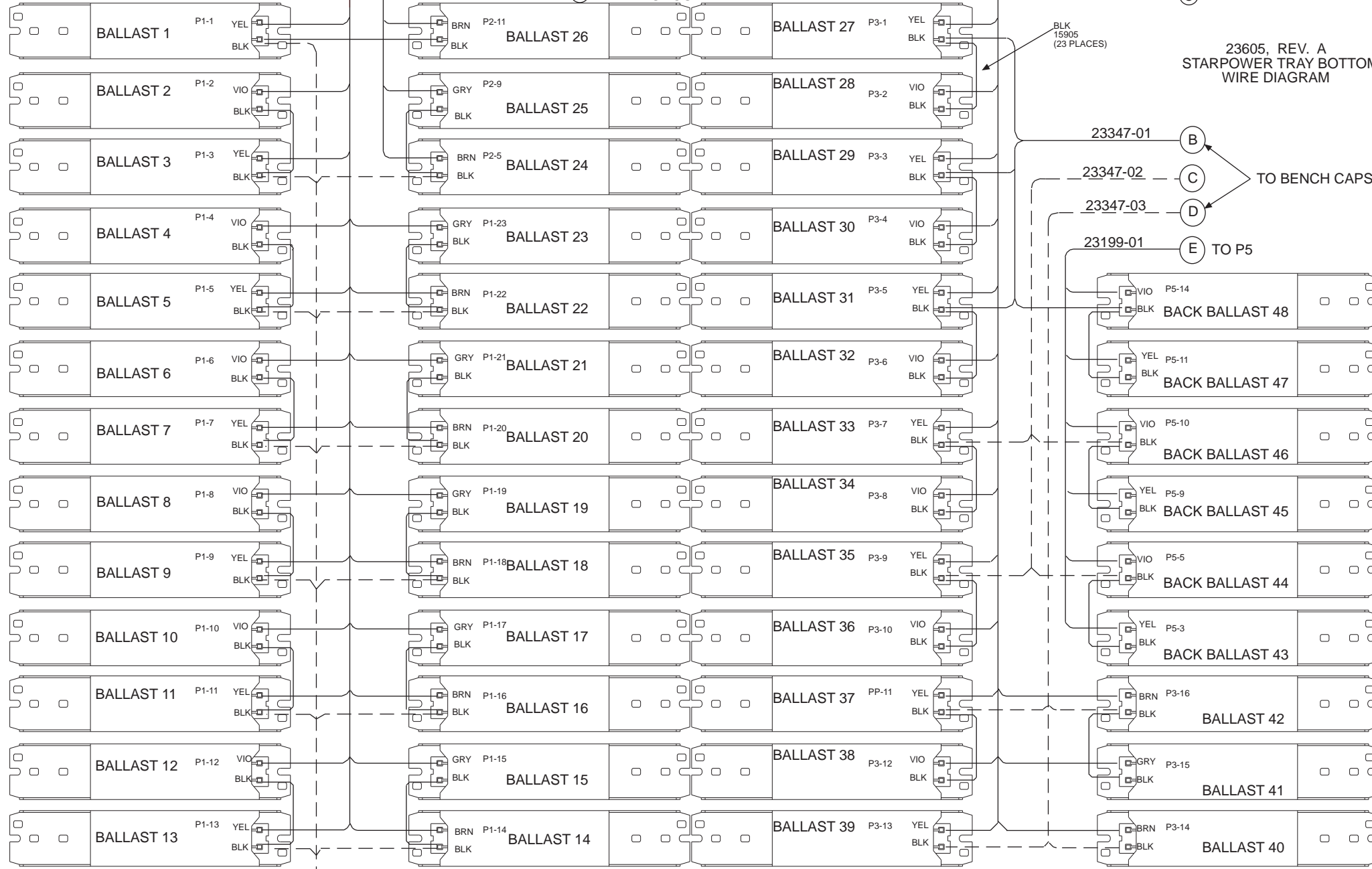

TO P2

(A)

23198-01

TO BENCH CAPS

TO P5

(F) TO CANOPY CAPS

23605, REV A
STARPOWER BENCH
WIRE DIAGRAM

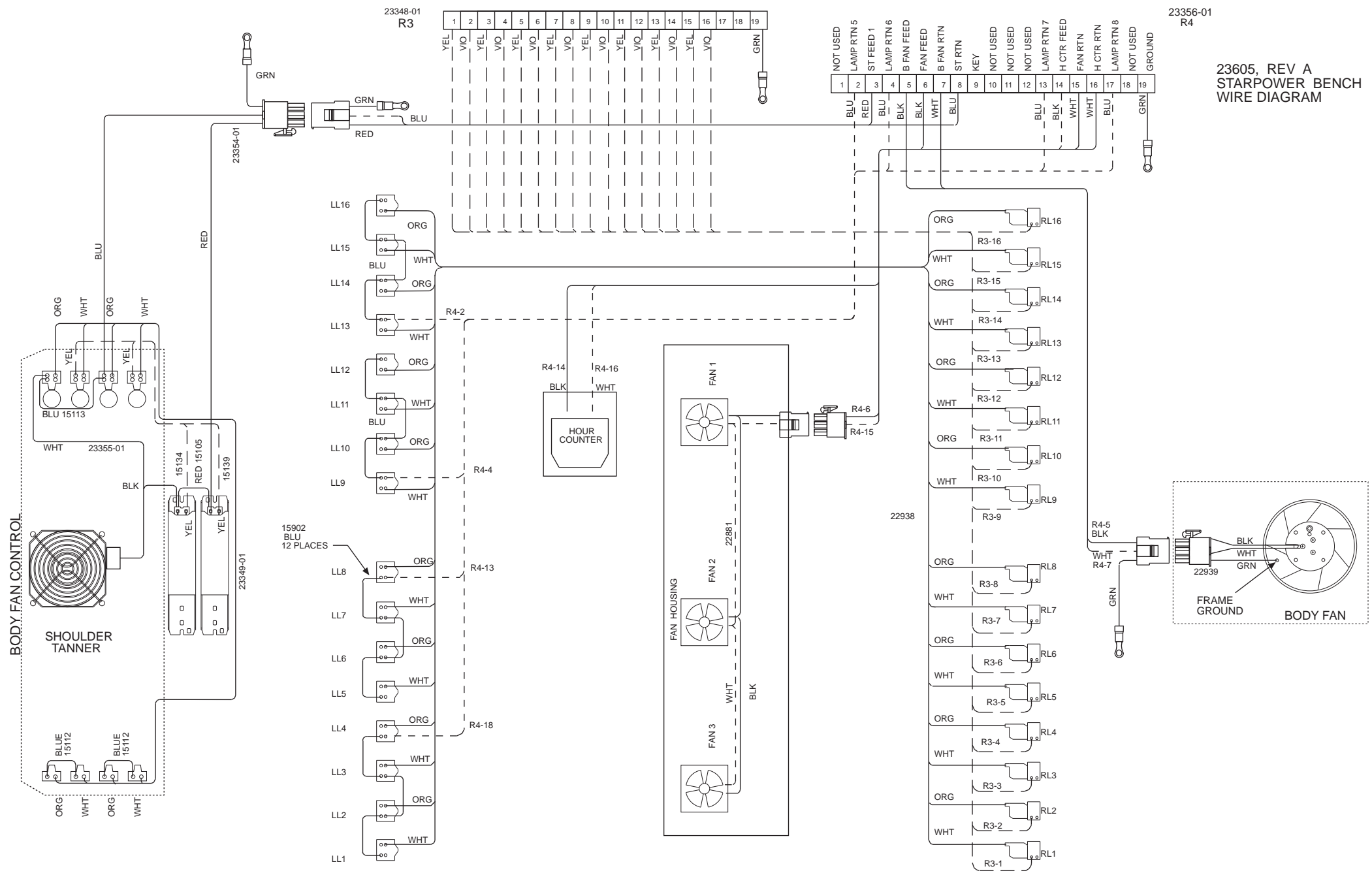

FRONT OF BED
(BOTTOM SIDE UP)

WARNING: ALTERING THE DESIGN, TIMER SYSTEM OR WIRING FROM THAT SHOWN HEREIN, WILL VOID THE WARRANTY, AND MAY RESULT IN A VIOLATION OF FEDERAL LAW.

23604, REV A
BACK LAMP SECTION
WIRE DIAGRAM

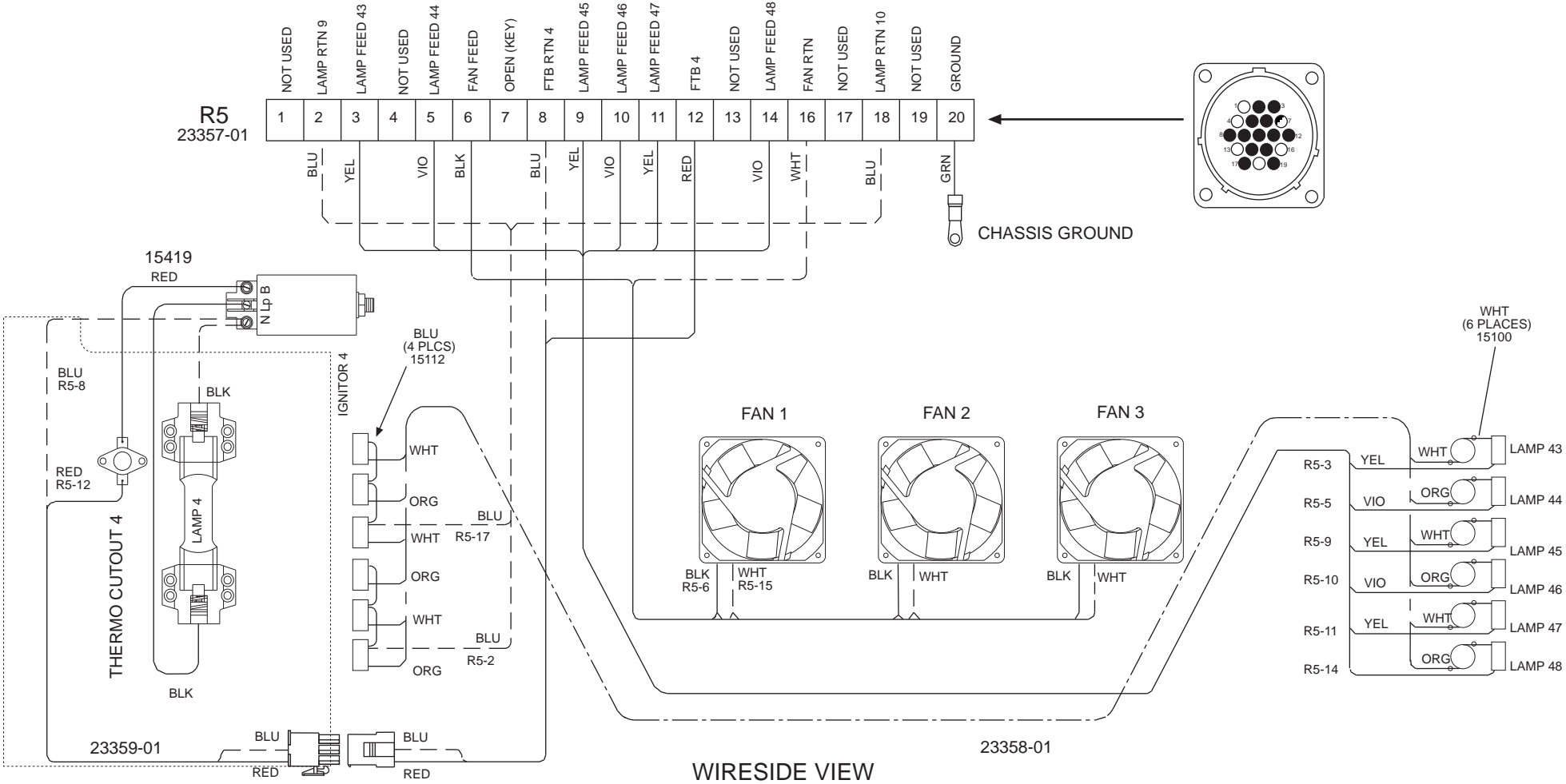

WIRESIDE VIEW

REAR FACE TANNER

23604, REV A
STARPOWER 3 FACE CANOPY
WIRE DIAGRAM

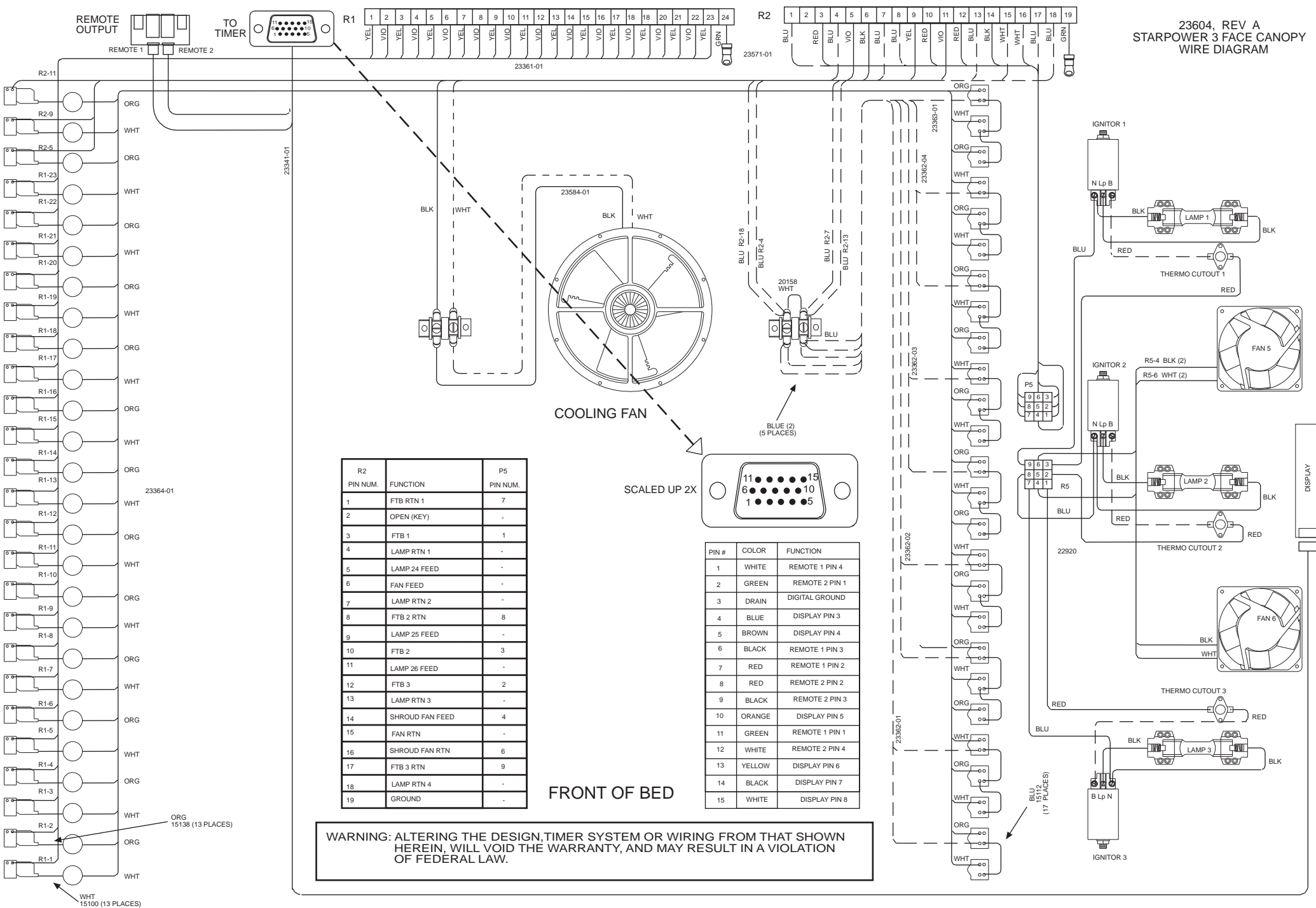

R2 PIN NUM.	FUNCTION	P5 PIN NUM.
1	FTB RTN 1	7
2	OPEN (KEY)	-
3	FTB 1	1
4	LAMP RTN 1	-
5	LAMP 24 FEED	-
6	FAN FEED	-
7	LAMP RTN 2	-
8	FTB 2 RTN	8
9	LAMP 25 FEED	-
10	FTB 2	3
11	LAMP 26 FEED	-
12	FTB 3	2
13	LAMP RTN 3	-
14	SHROUD FAN FEED	4
15	FAN RTN	-
16	SHROUD FAN RTN	6
17	FTB 3 RTN	9
18	LAMP RTN 4	-
19	GROUND	-

PIN #	COLOR	FUNCTION
1	WHITE	REMOTE 1 PIN 4
2	GREEN	REMOTE 2 PIN 1
3	DRAIN	DIGITAL GROUND
4	BLUE	DISPLAY PIN 3
5	BROWN	DISPLAY PIN 4
6	BLACK	REMOTE 1 PIN 3
7	RED	REMOTE 1 PIN 2
8	RED	REMOTE 2 PIN 2
9	BLACK	REMOTE 2 PIN 3
10	ORANGE	DISPLAY PIN 5
11	GREEN	REMOTE 1 PIN 1
12	WHITE	REMOTE 2 PIN 4
13	YELLOW	DISPLAY PIN 6
14	BLACK	DISPLAY PIN 7
15	WHITE	DISPLAY PIN 8

WARNING: ALTERING THE DESIGN, TIMER SYSTEM OR WIRING FROM THAT SHOWN HEREIN, WILL VOID THE WARRANTY, AND MAY RESULT IN A VIOLATION OF FEDERAL LAW.

SHOULDER TANNER
WITH SPEAKERS
& BODY FAN

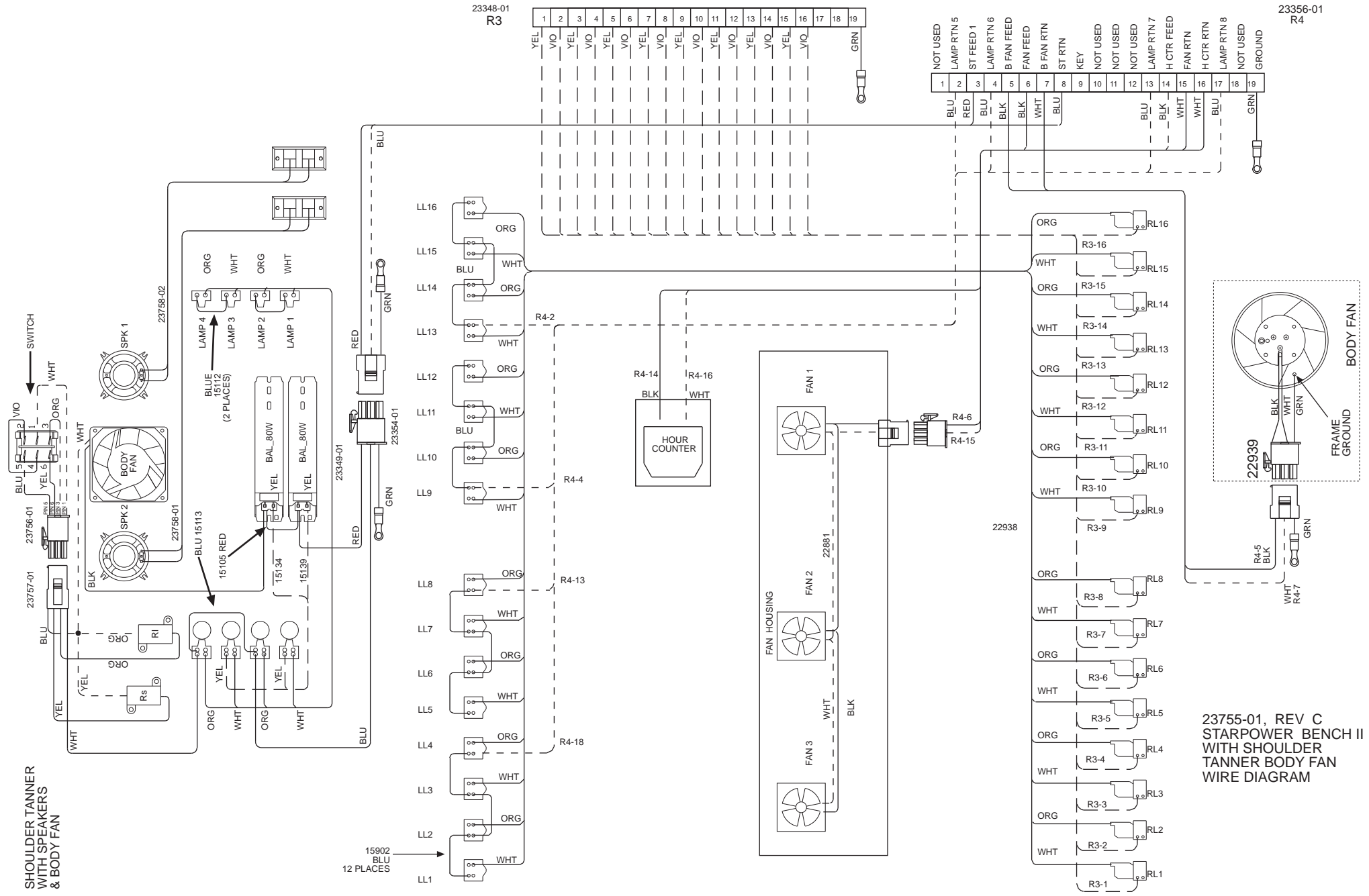

23755-01, REV C
STARPOWER BENCH II
WITH SHOULDER
TANNER BODY FAN
WIRE DIAGRAM

FRONT OF BED
(BOTTOM SIDE UP)

WARNING: ALTERING THE DESIGN, TIMER SYSTEM OR WIRING FROM THAT SHOWN
HEREIN, WILL VOID THE WARRANTY, AND MAY RESULT IN A VIOLATION
OF FEDERAL LAW.

SHOULDER TANNER
WITH SPEAKERS
& IMPROVED
BODY FAN

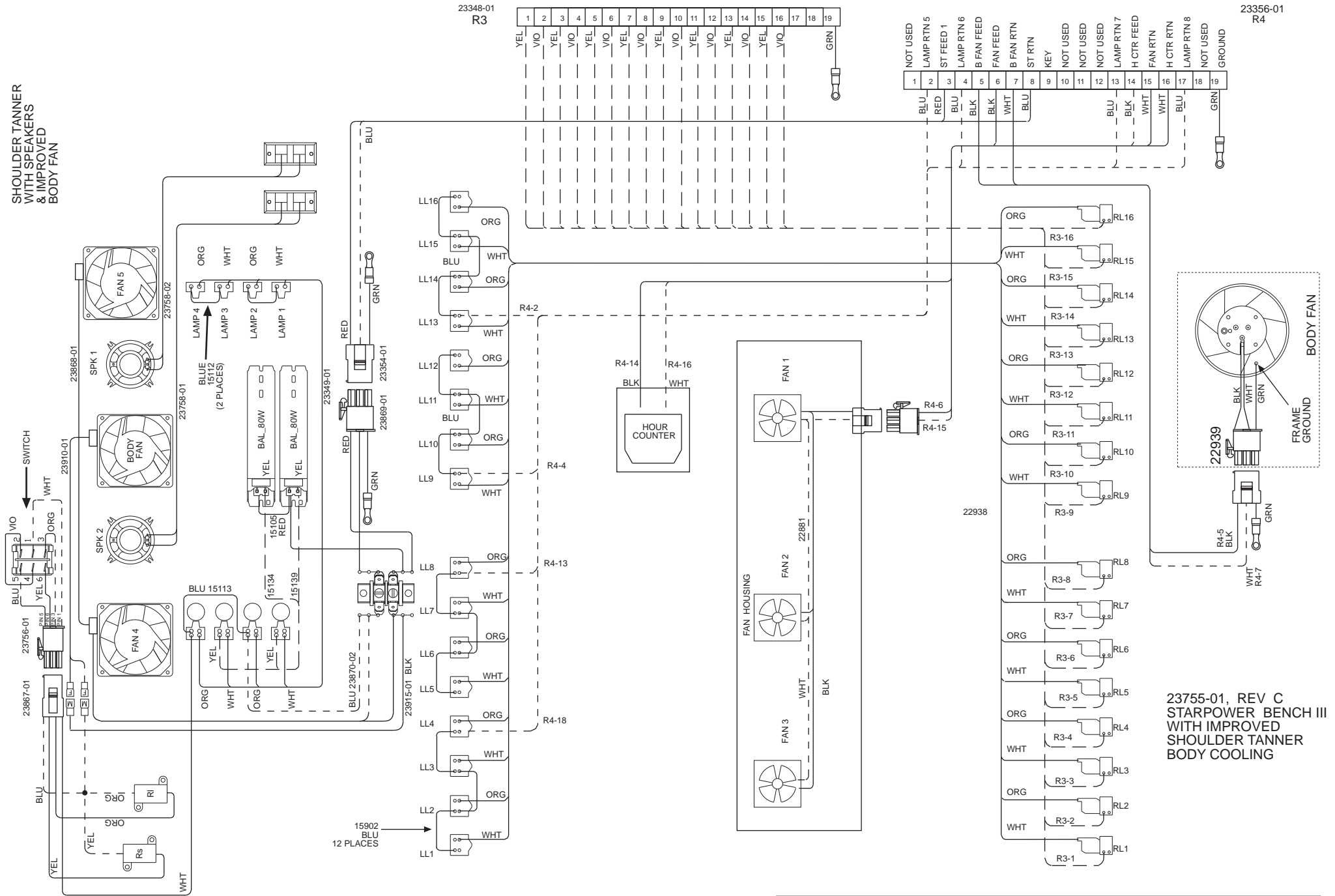

23348-01
R3

23356-01
R4

FRONT OF BED
(BOTTOM SIDE UP)

WARNING: ALTERING THE DESIGN, TIMER SYSTEM OR WIRING FROM THAT SHOWN
HEREIN, WILL VOID THE WARRANTY, AND MAY RESULT IN A VIOLATION
OF FEDERAL LAW.

23755-01, REV C
STARPOWER BENCH III
WITH IMPROVED
SHOULDER TANNER
BODY COOLING