

CONTROL MODULE  
BOTTOM LEFT SIDE

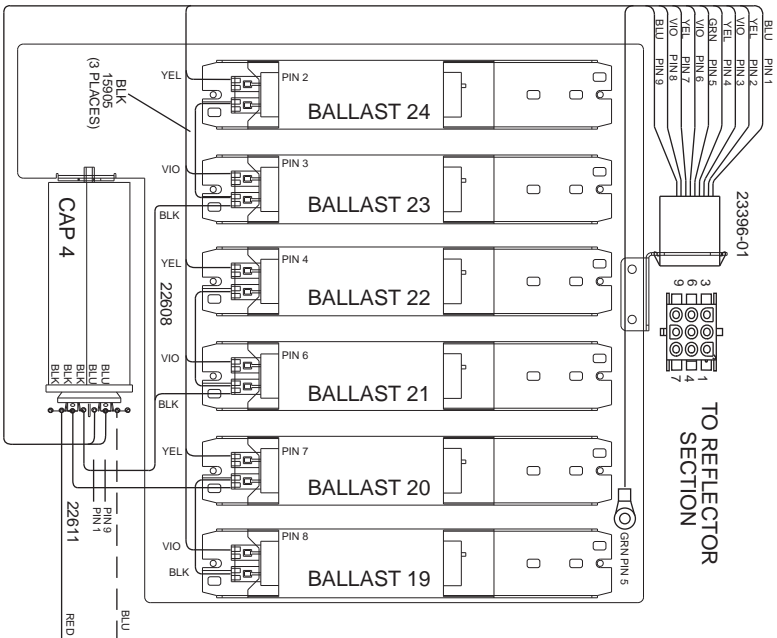

E

CONTROL MODULE  
BOTTOM RIGHT SIDE

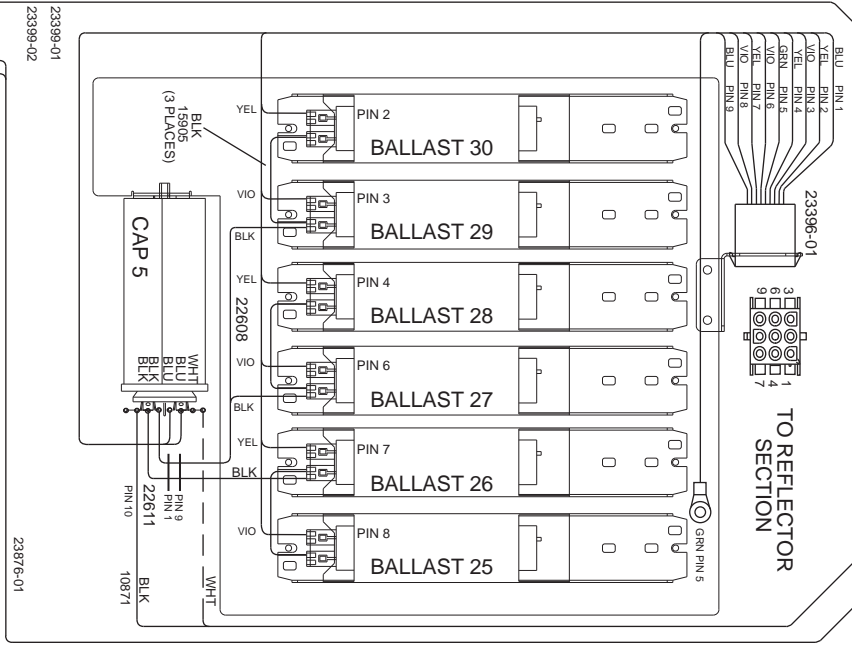

A

B

C

D

P = PLUG  
R = RECEPTACLE

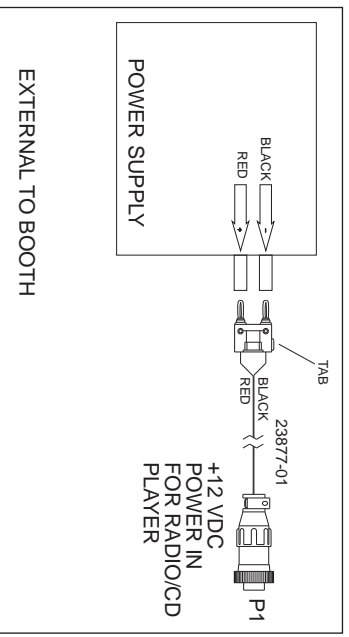

23379-01

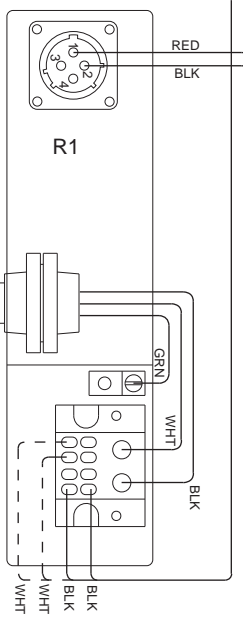
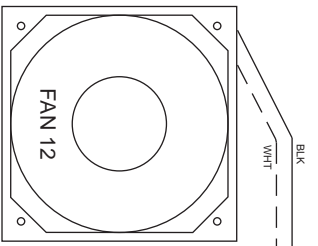

23399-01  
23399-02

23876-01

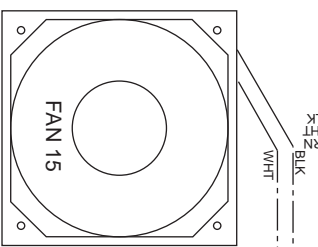

**WARNING : ALTERING THE DESIGN, TIMER SYSTEM, OR WIRING FROM THAT SHOWN HEREIN, WILL VOID THE WARRANTY, AND MAY RESULT IN A VIOLATION OF FEDERAL LAW.**

**CONTROL MODULE  
TOP LEFT SIDE**

23379-01

23874-01 REV B

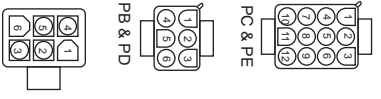
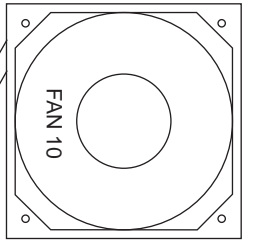

**PLUG INSERTION  
END VIEW**

**P = PLUG  
R = RECEPTACLE**

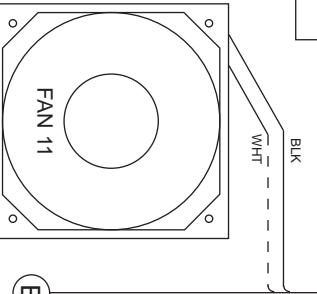

(E)

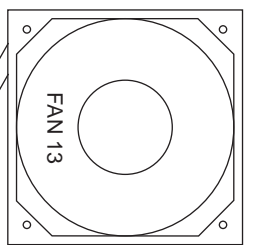
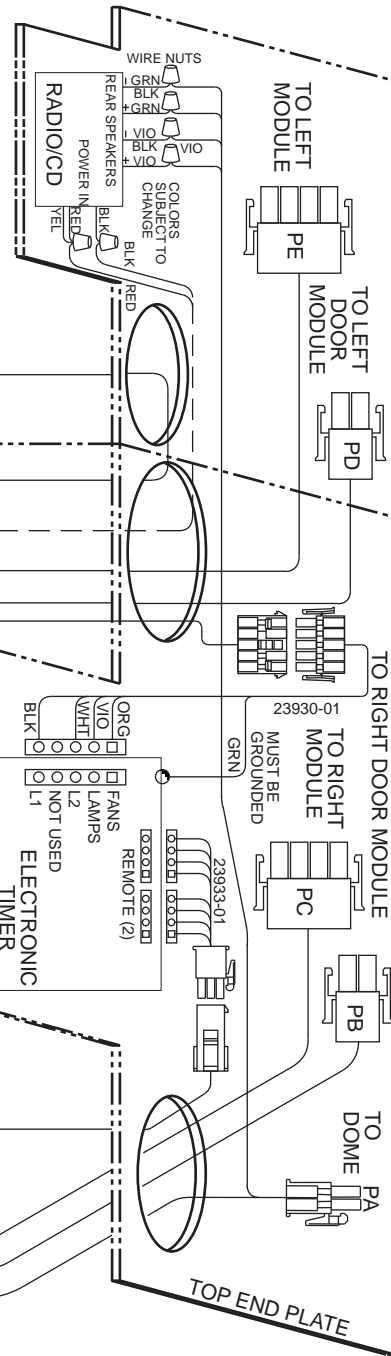

**CONTROL MODULE  
TOP RIGHT SIDE**

23378-02

23294-02

23875-01

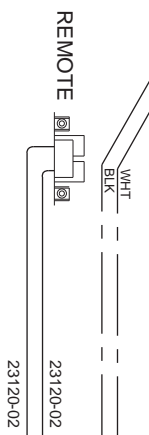

(A)  
(C)

(B)

(D)

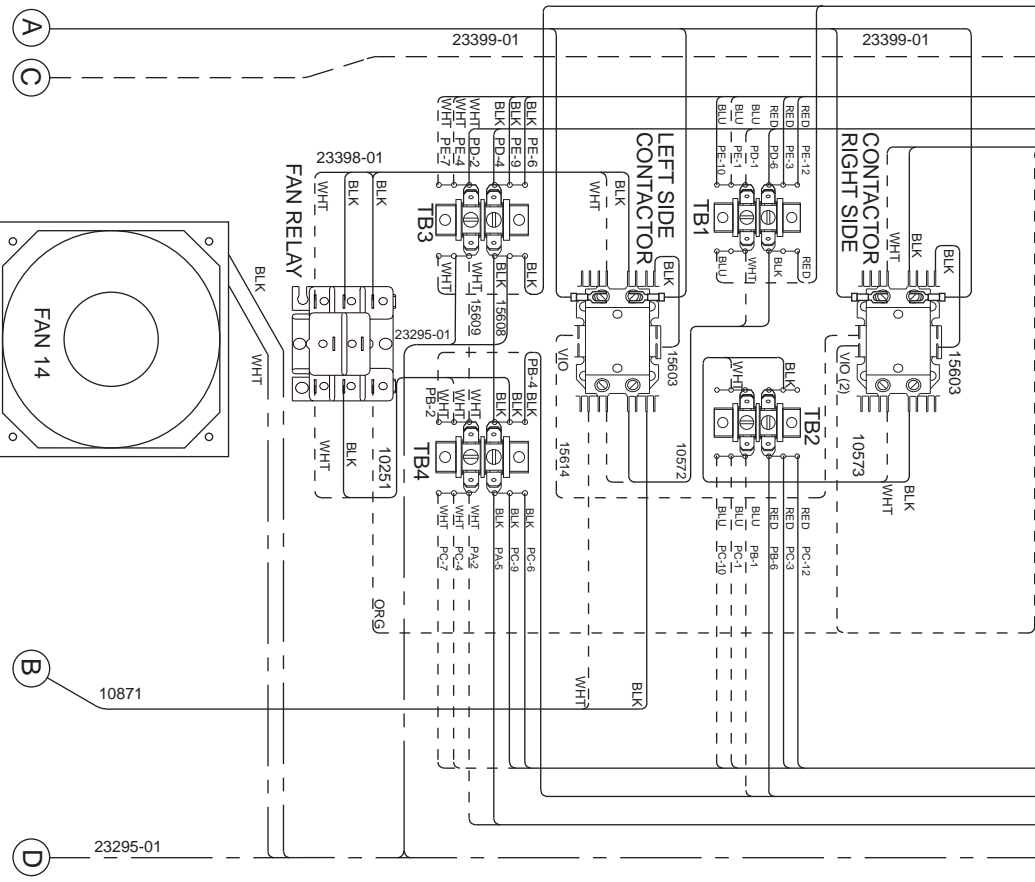

**SUNDOME  
LEFT MODULE  
(RIGHT MODULE)**

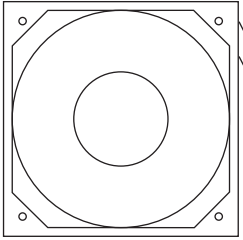

FAN 6  
(FAN 18)

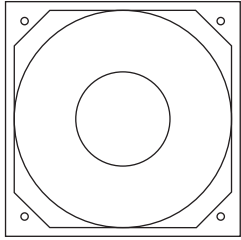
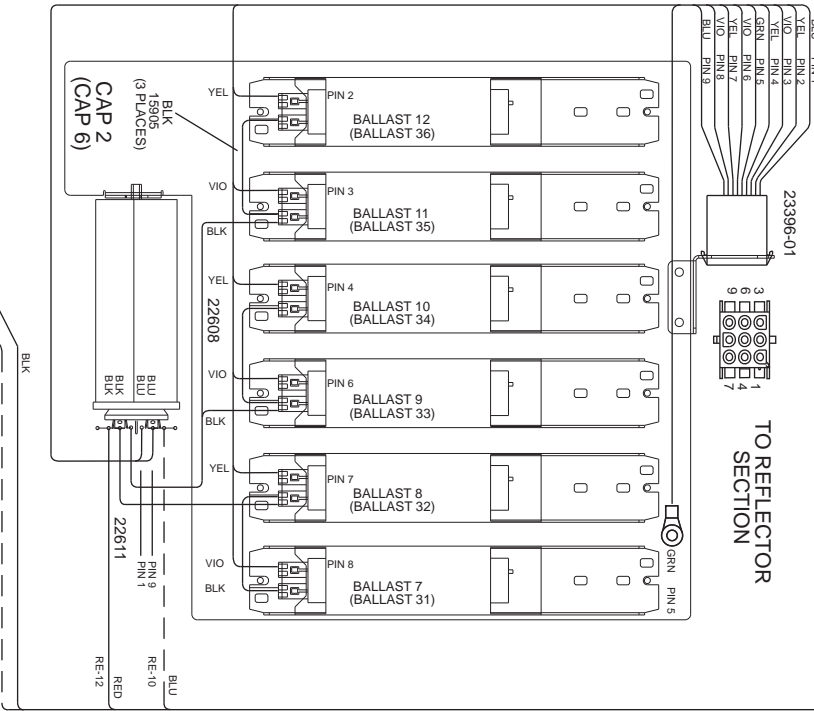

FAN 5  
(FAN 17)

**NOTE:**  
1. RIGHT MODULE IS A MIRROR IMAGE OF  
LEFT MODULE, RIGHT MODULE PARTS IN  
PARENTHESES

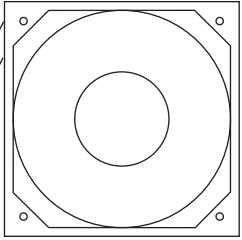

FAN 4  
(FAN 16)

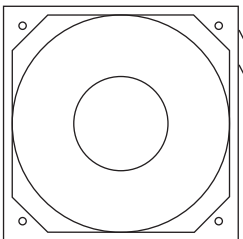
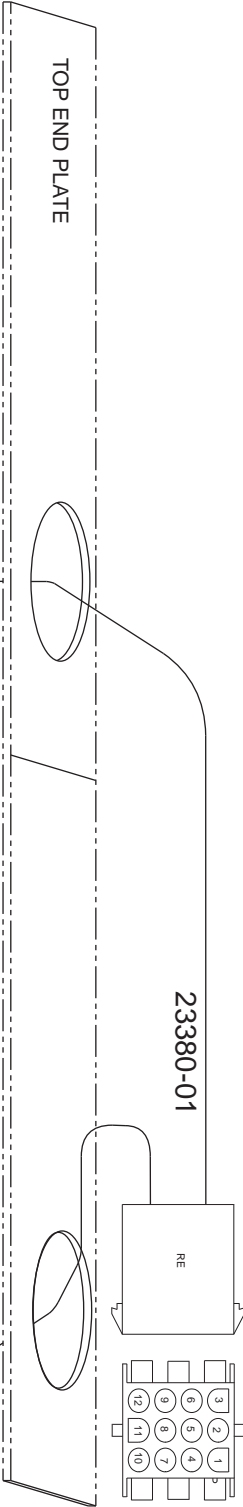

FAN 9  
(FAN 21)

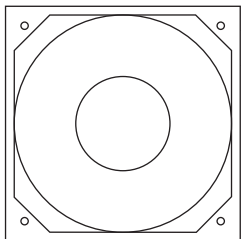
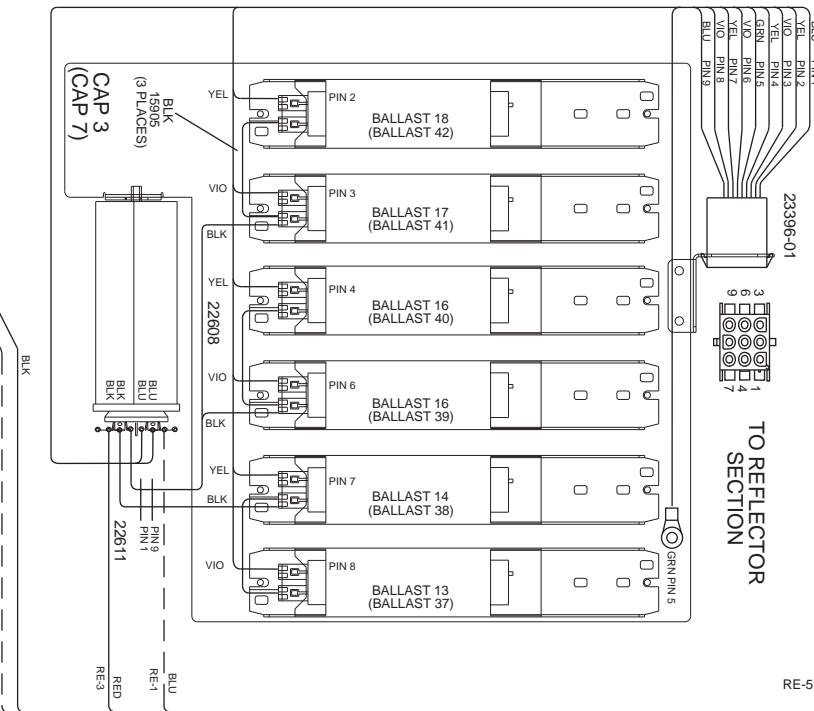

FAN 8  
(FAN 20)

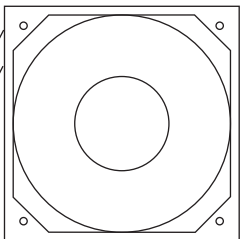

FAN 7  
(FAN 19)

SUNDOME  
LEFT DOOR MODULE  
(RIGHT DOOR MODULE)

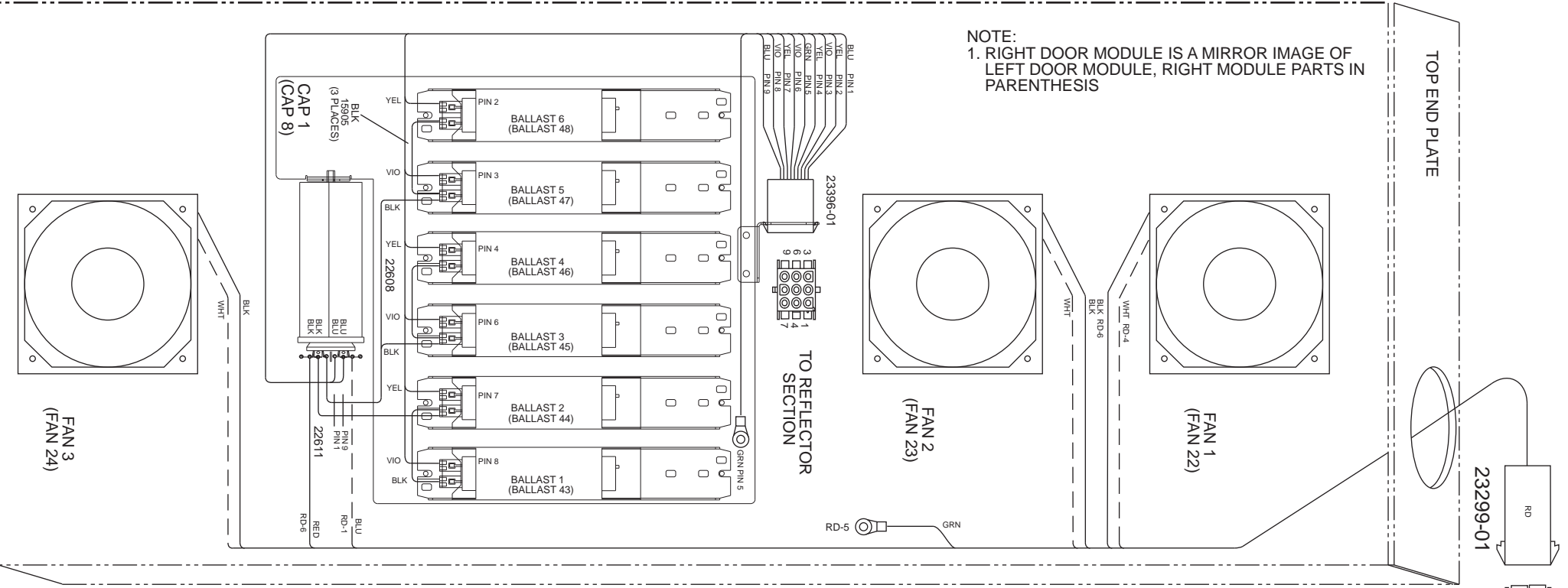

**WARNING : ALTERING THE DESIGN, TIMER SYSTEM, OR WIRING FROM THAT SHOWN HEREIN, WILL VOID THE WARRANTY, AND MAY RESULT IN A VIOLATION OF FEDERAL LAW.**

23894-01, REV A  
 SUNDOME  
 LAMP/REFLECTOR SECTIONS

REFLECTOR SECTION (8)

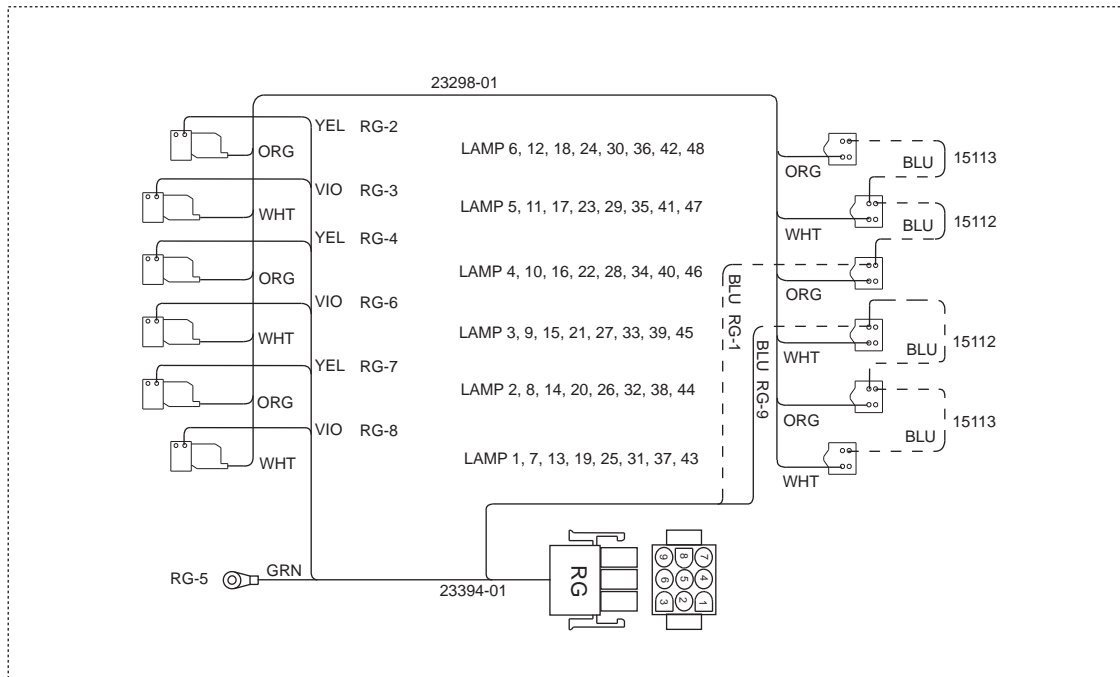

- NOTES:
1. LAMP 1 IS THE LEFT MOST LAMP LOOKING AT THE FRONT OF THE SUNDOME UNIT. LAMP 48 IS THE RIGHT MOST LAMP

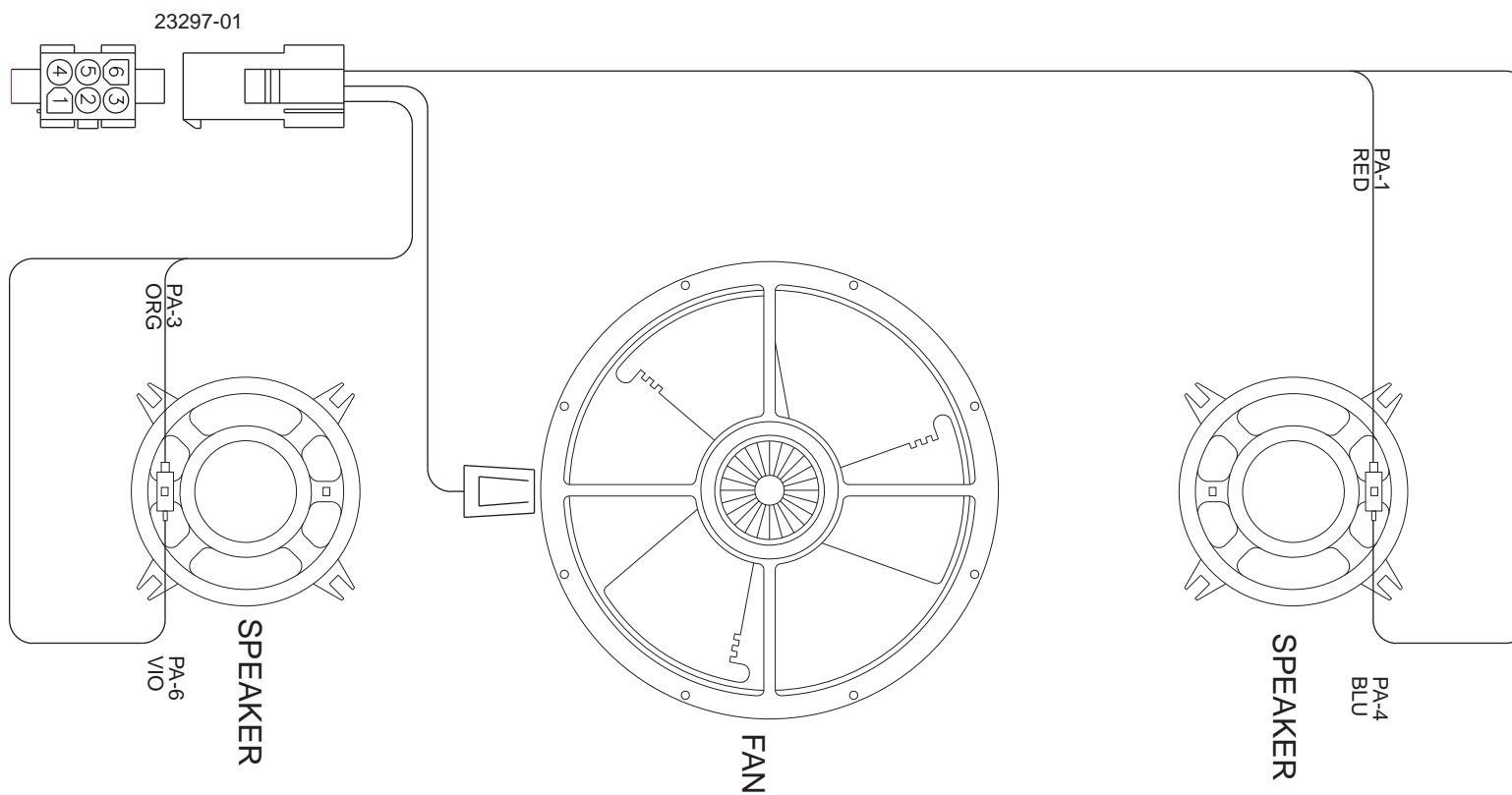

**WARNING : ALTERING THE DESIGN, TIMER SYSTEM, OR WIRING FROM THAT SHOWN HEREIN, WILL VOID THE WARRANTY, AND MAY RESULT IN A VIOLATION OF FEDERAL LAW.**