

CONTROL MODULE  
BOTTOM LEFT SIDE

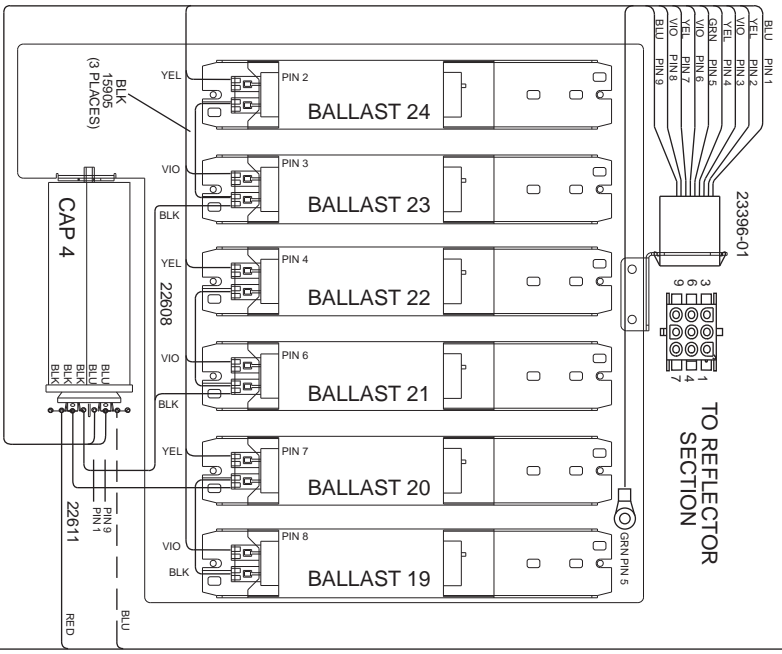

E

CONTROL MODULE  
BOTTOM RIGHT SIDE

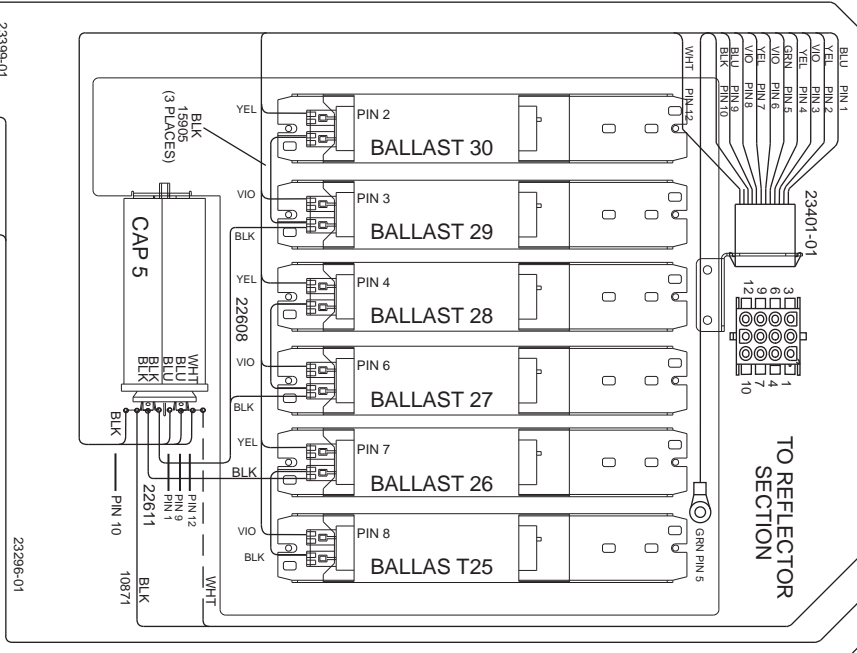

B

C

D

23365-01 REV A

P = PLUG  
R = RECEPTACLE

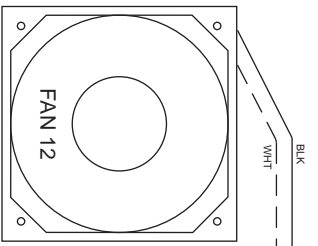

23379-01

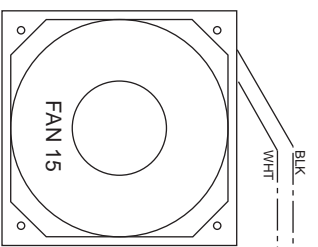
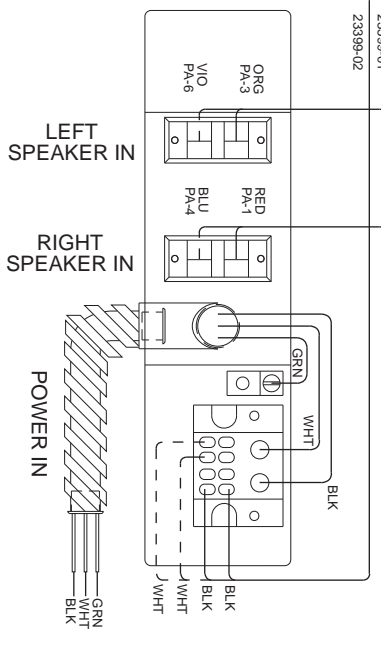

23296-01



**SUNDOME  
LEFT MODULE  
(RIGHT MODULE)**

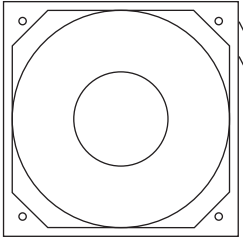

FAN 6  
(FAN 18)

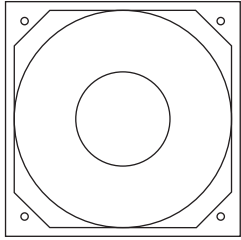
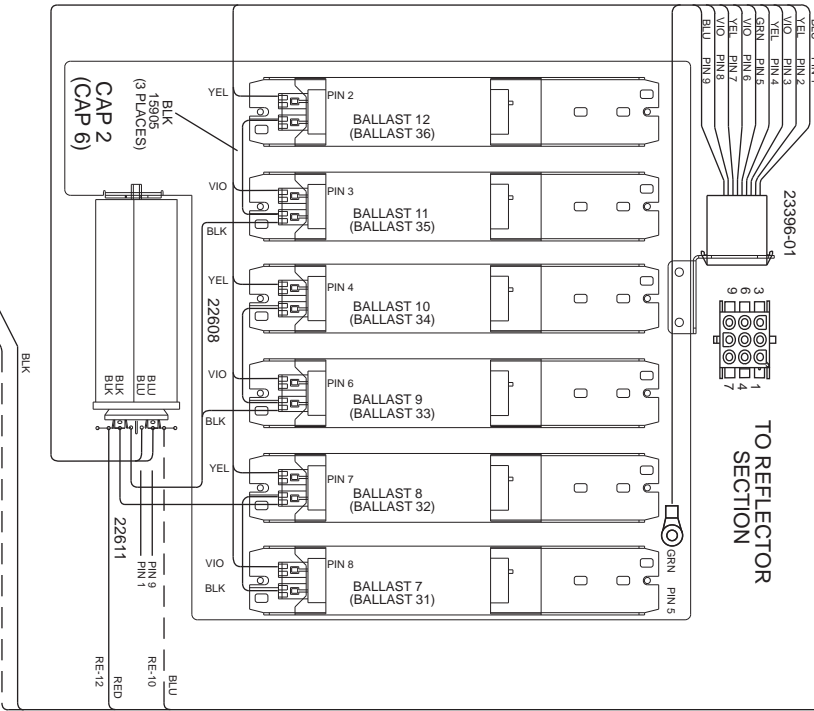

FAN 5  
(FAN 17)

**NOTE:**  
1. RIGHT MODULE IS A MIRROR IMAGE OF LEFT MODULE, RIGHT MODULE PARTS IN PARENTHESIS

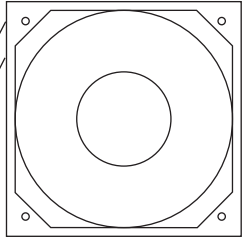

FAN 4  
(FAN 16)

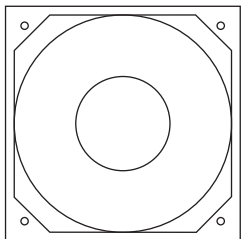
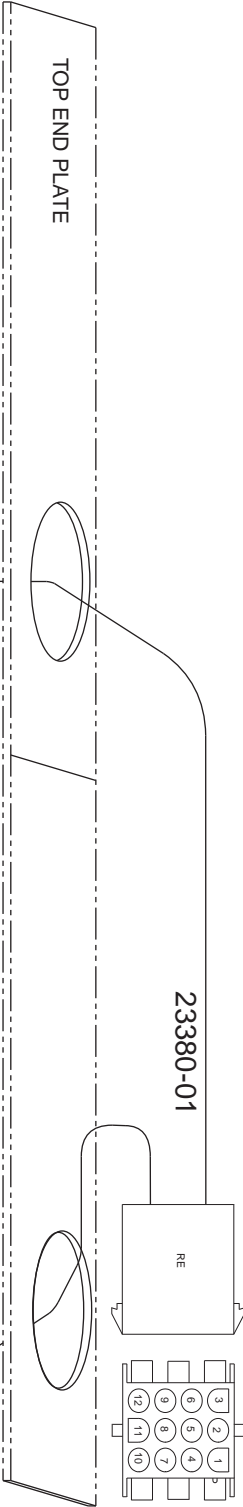

FAN 8  
(FAN 20)

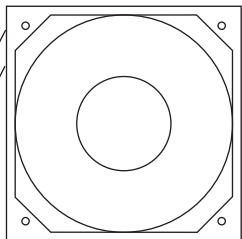
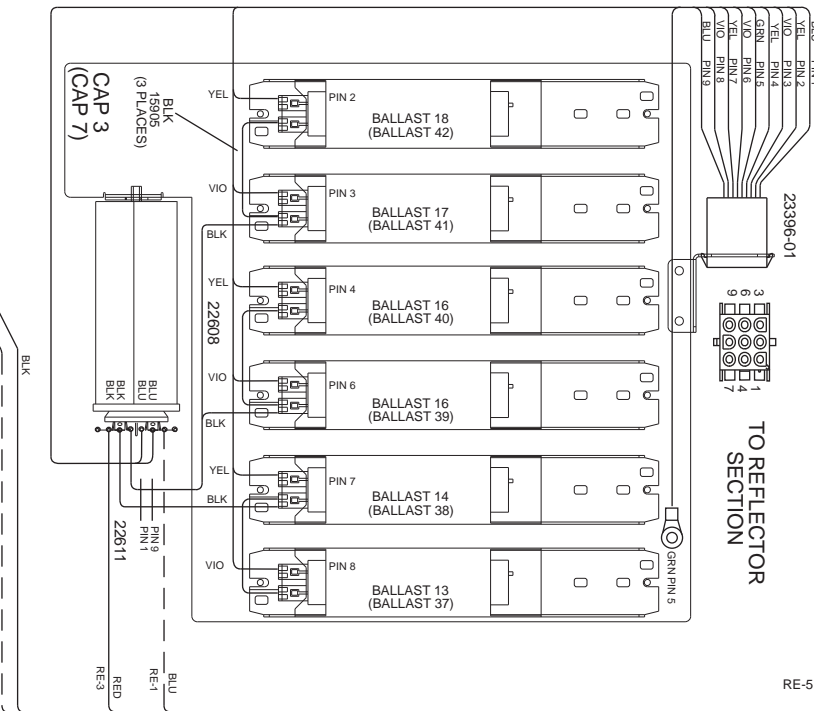

FAN 7  
(FAN 19)

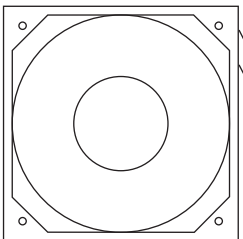

FAN 9  
(FAN 21)

SUNDOME  
LEFT DOOR MODULE  
(RIGHT DOOR MODULE)

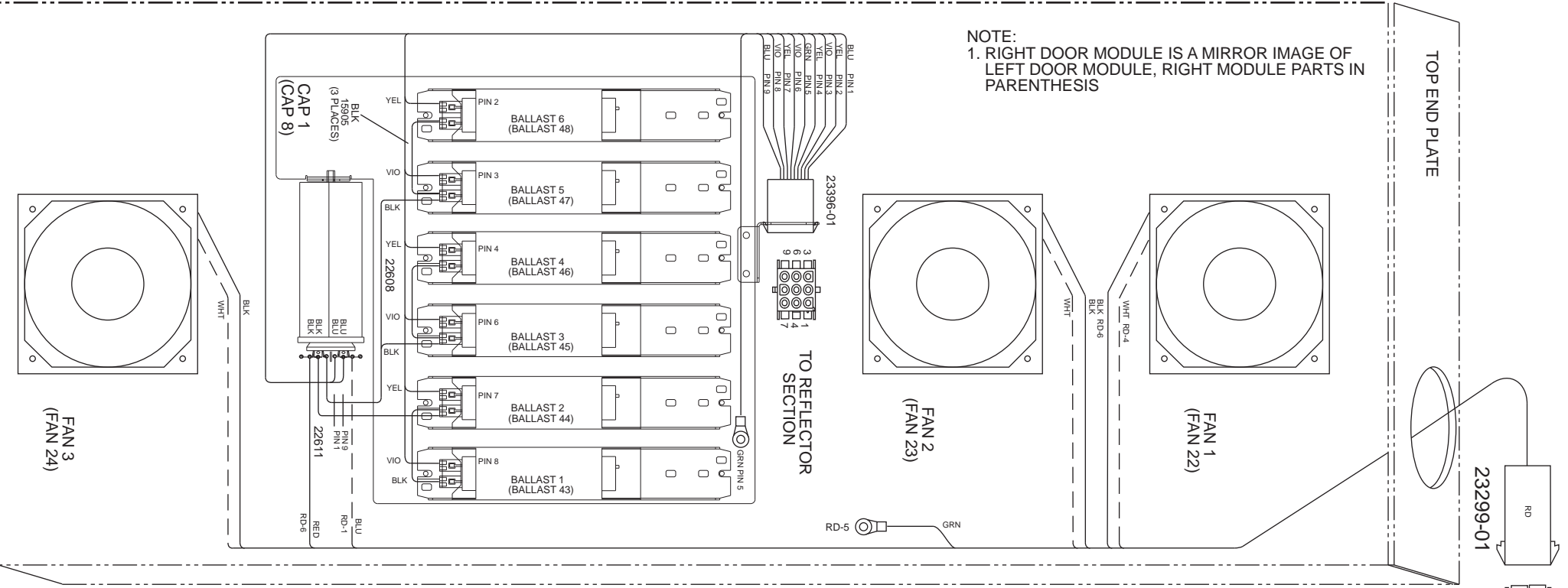

NOTE:  
1. RIGHT DOOR MODULE IS A MIRROR IMAGE OF LEFT DOOR MODULE, RIGHT MODULE PARTS IN PARENTHESIS

**WARNING : ALTERING THE DESIGN, TIMER SYSTEM, OR WIRING FROM THAT SHOWN HEREIN, WILL VOID THE WARRANTY, AND MAY RESULT IN A VIOLATION OF FEDERAL LAW.**



# SUNDOME DOME ASSEMBLY

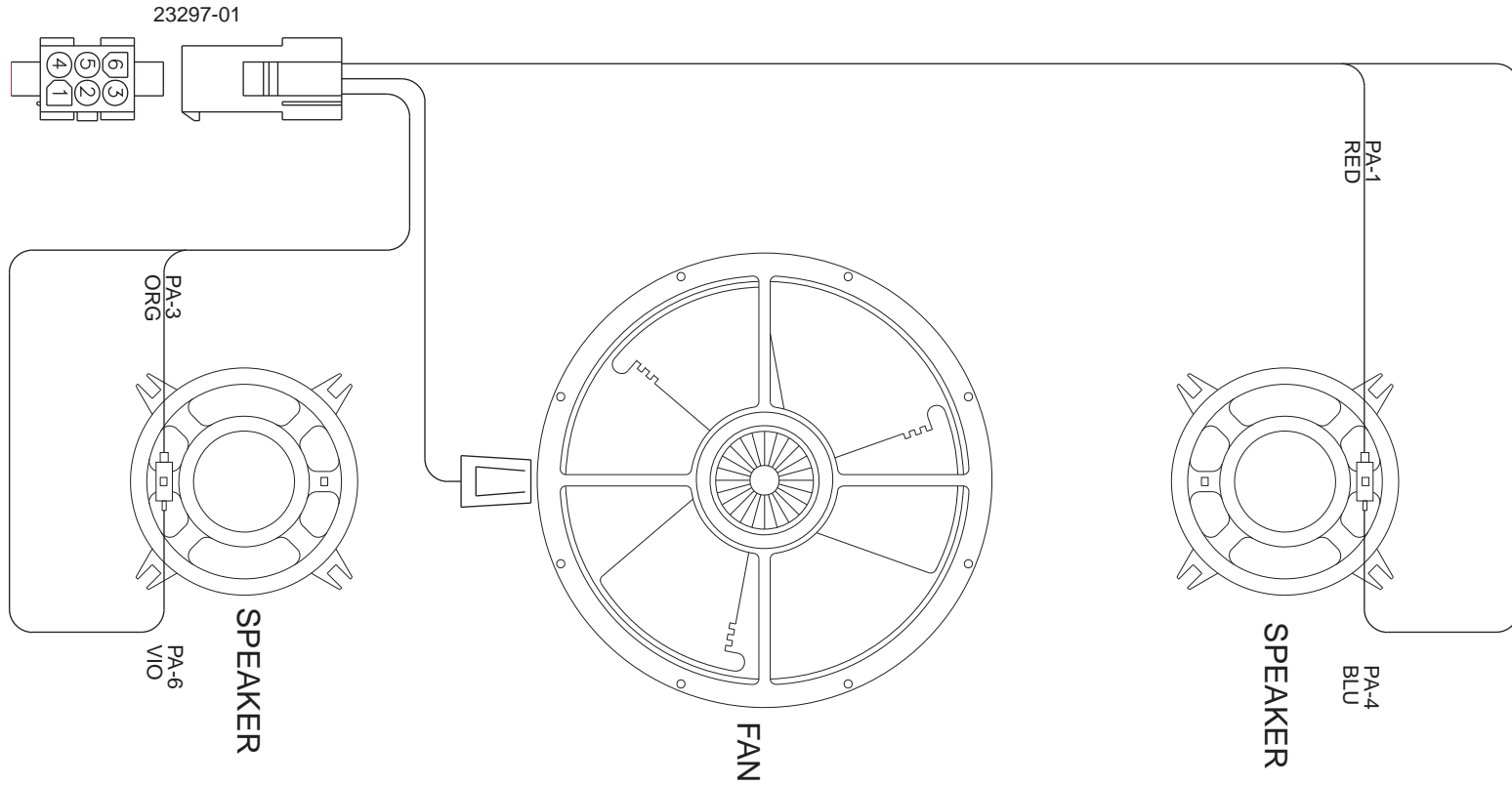

**WARNING : ALTERING THE DESIGN, TIMER SYSTEM, OR WIRING FROM THAT SHOWN  
HEREIN, WILL VOID THE WARRANTY, AND MAY RESULT IN A VIOLATION  
OF FEDERAL LAW.**