

ZX32 SPEED 175 SYSTEM BENCH

WARNING : ALTERING THE DESIGN, TIMER SYSTEM, OR WIRING FROM THAT SHOWN HEREIN, WILL VOID THE WARRANTY, AND MAY RESULT IN A VIOLATION OF FEDERAL LAW.

ZX32 SPEED 175 SYSTEM CANOPY

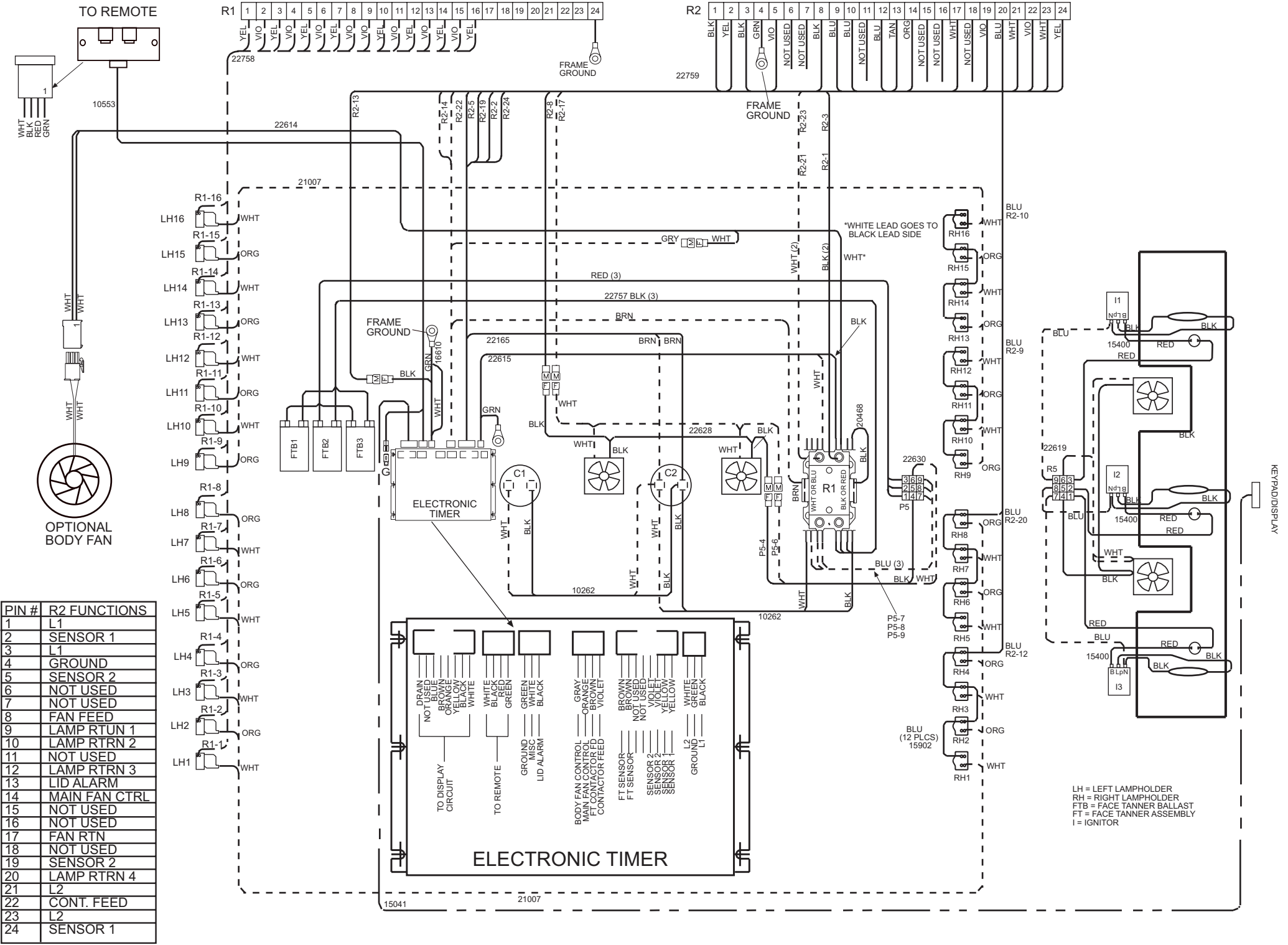

TO REMOTE

R1	1	2	3	4	5	6	7	8	9	10	11	12	13	14	15	16	17	18	19	20	21	22	23	24
	YEL	VIO	YEL	VIO	YEL	VIO	YEL	VIO	YEL	VIO	YEL	VIO	YEL	VIO	YEL	VIO	YEL	VIO	YEL	VIO	YEL	VIO	YEL	VIO

R2	1	2	3	4	5	6	7	8	9	10	11	12	13	14	15	16	17	18	19	20	21	22	23	24
	BLK	YEL	BLK	GRN	VIO	NOT USED	NOT USED	BLK	BLU	BLU	BLU	BLU	TAN	ORG	NOT USED	NOT USED	WHT	NOT USED	BLU	WHT	VIO	WHT	WHT	YEL

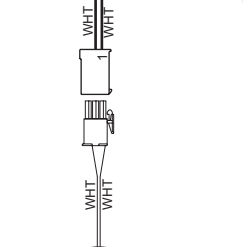
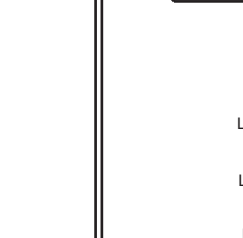
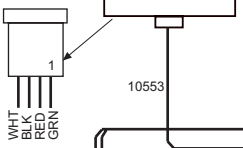

PIN #	R2 FUNCTIONS
1	L1
2	SENSOR 1
3	L1
4	GROUND
5	SENSOR 2
6	NOT USED
7	NOT USED
8	FAN FEED
9	LAMP RTUN 1
10	LAMP RTRN 2
11	NOT USED
12	LAMP RTRN 3
13	LID ALARM
14	MAIN FAN CTRL
15	NOT USED
16	NOT USED
17	FAN RTN
18	NOT USED
19	SENSOR 2
20	LAMP RTRN 4
21	L2
22	CONT. FEED
23	L2
24	SENSOR 1

- LH16 R1-16 WHT
- LH15 R1-15 ORG
- LH14 R1-14 WHT
- LH13 R1-13 ORG
- LH12 R1-12 WHT
- LH11 R1-11 ORG
- LH10 R1-10 WHT
- LH9 R1-9 ORG
- LH8 R1-8 ORG
- LH7 R1-7 WHT
- LH6 R1-6 ORG
- LH5 R1-5 WHT
- LH4 R1-4 ORG
- LH3 R1-3 WHT
- LH2 R1-2 ORG
- LH1 R1-1 WHT

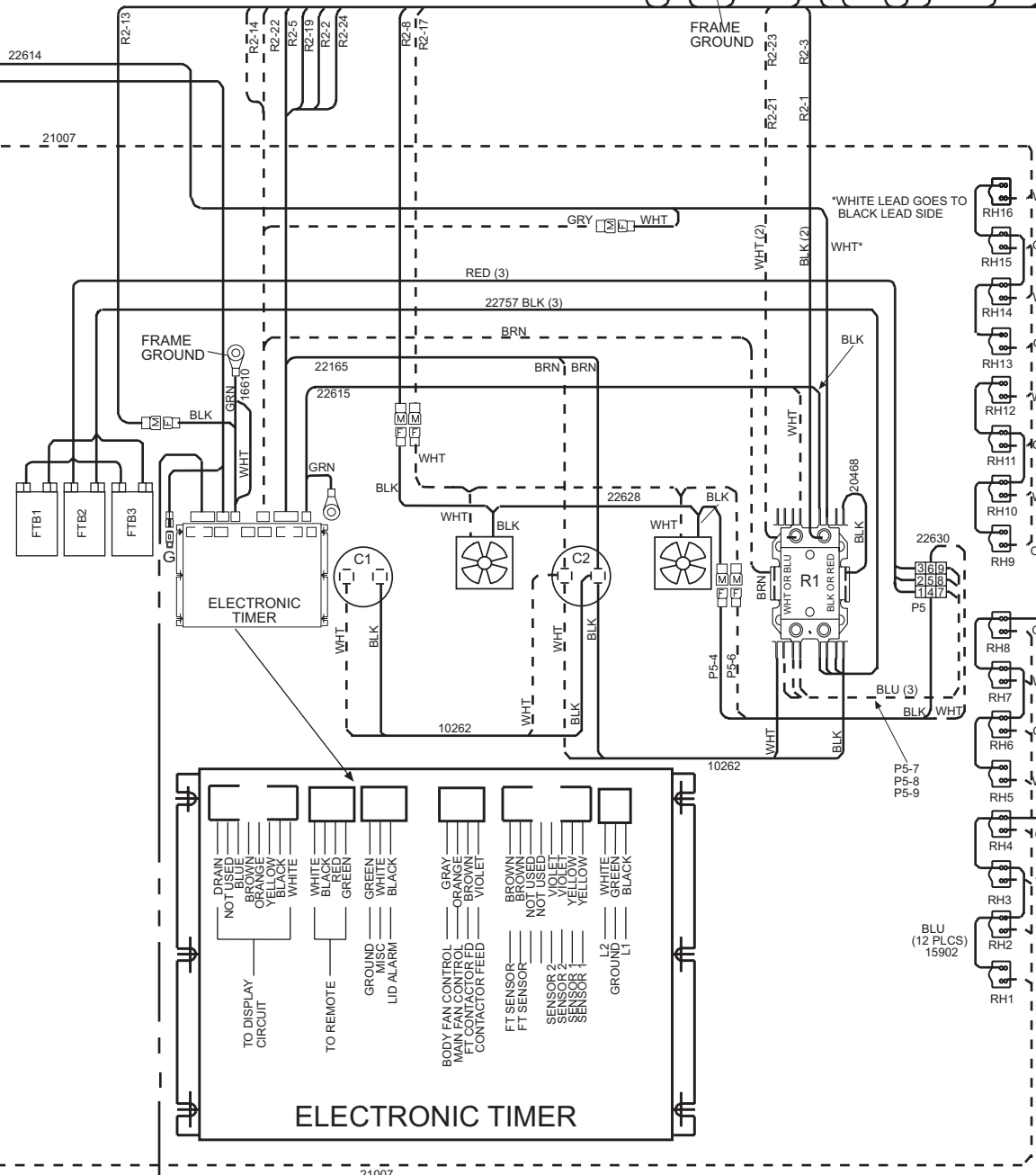

LH = LEFT LAMPHOLDER
 RH = RIGHT LAMPHOLDER
 FTB = FACE TANNER BALLAST
 I = IGNITOR

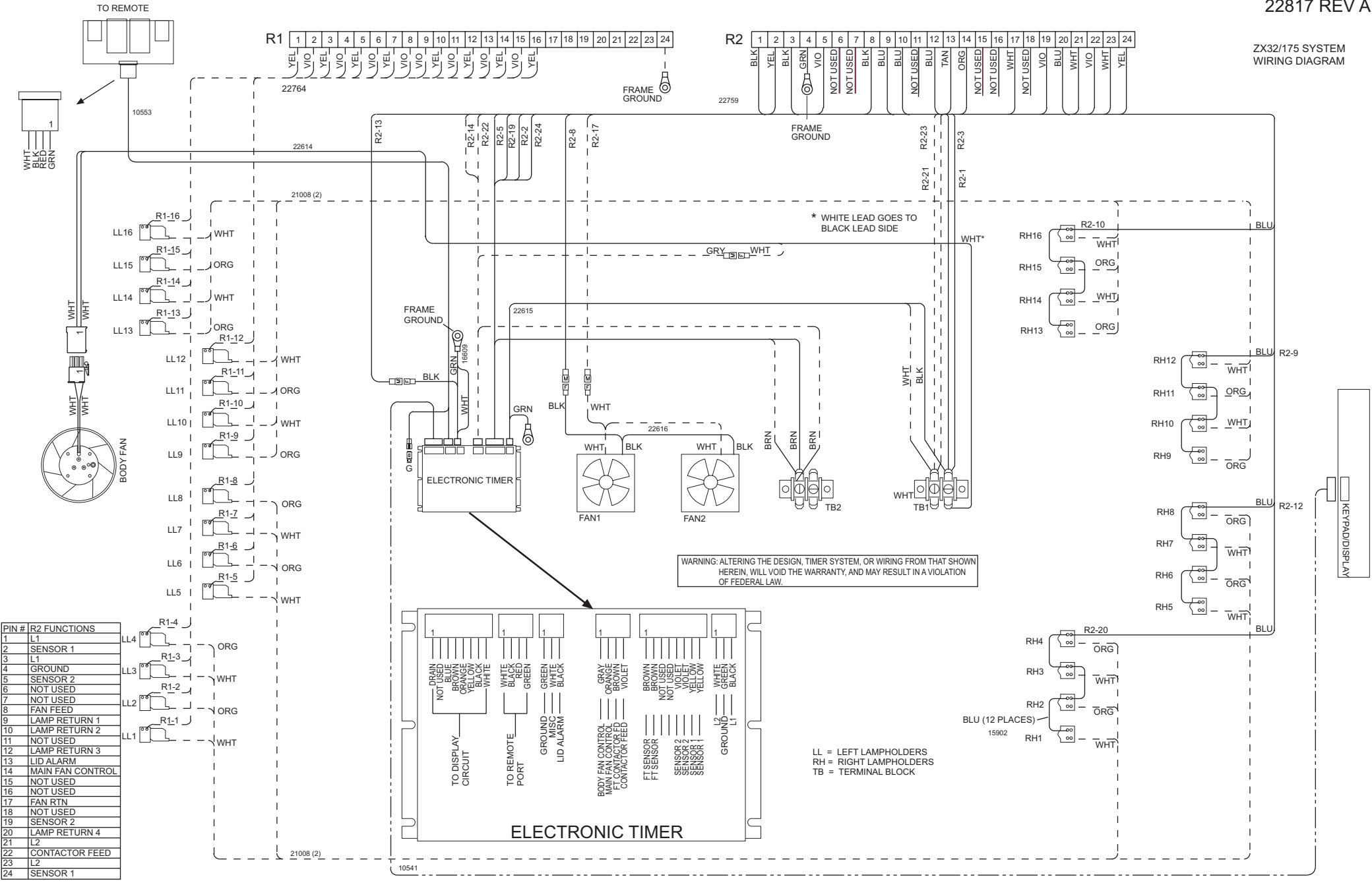

R1

1	2	3	4	5	6	7	8	9	10	11	12	13	14	15	16	17	18	19	20	21	22	23	24	
YEL	VIO	YEL	VIO	YEL	VIO	YEL	VIO	YEL	VIO	YEL	VIO	YEL	VIO	YEL	VIO									

R2

1	2	3	4	5	6	7	8	9	10	11	12	13	14	15	16	17	18	19	20	21	22	23	24
BLK	YEL	BLK	GRN	VIO	NOT USED	NOT USED	BLK	BLU	BLU	BLU	TAN	ORG	NOT USED	NOT USED	WHT	NOT USED	VIO	BLU	BLU	WHT	VIO	WHT	YEL

PIN #	R2 FUNCTIONS
1	L1
2	SENSOR 1
3	L1
4	GROUND
5	SENSOR 2
6	NOT USED
7	NOT USED
8	FAN FEED
9	LAMP RETURN 1
10	LAMP RETURN 2
11	NOT USED
12	LAMP RETURN 3
13	LID ALARM
14	MAIN FAN CONTROL
15	NOT USED
16	NOT USED
17	FAN RTN
18	NOT USED
19	SENSOR 2
20	LAMP RETURN 4
21	L2
22	CONTACTOR FEED
23	L2
24	SENSOR 1

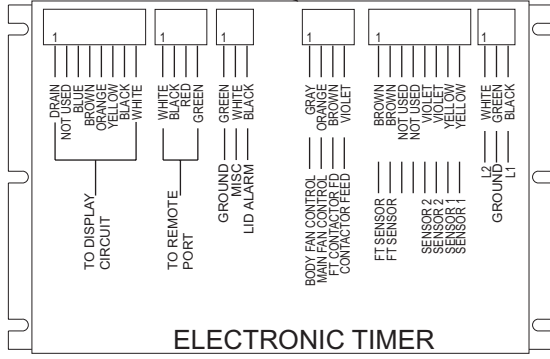

WARNING: ALTERING THE DESIGN, TIMER SYSTEM, OR WIRING FROM THAT SHOWN HEREIN, WILL VOID THE WARRANTY, AND MAY RESULT IN A VIOLATION OF FEDERAL LAW.

LL = LEFT LAMP HOLDERS
RH = RIGHT LAMP HOLDERS
TB = TERMINAL BLOCK

BLU (12 PLACES)
15902

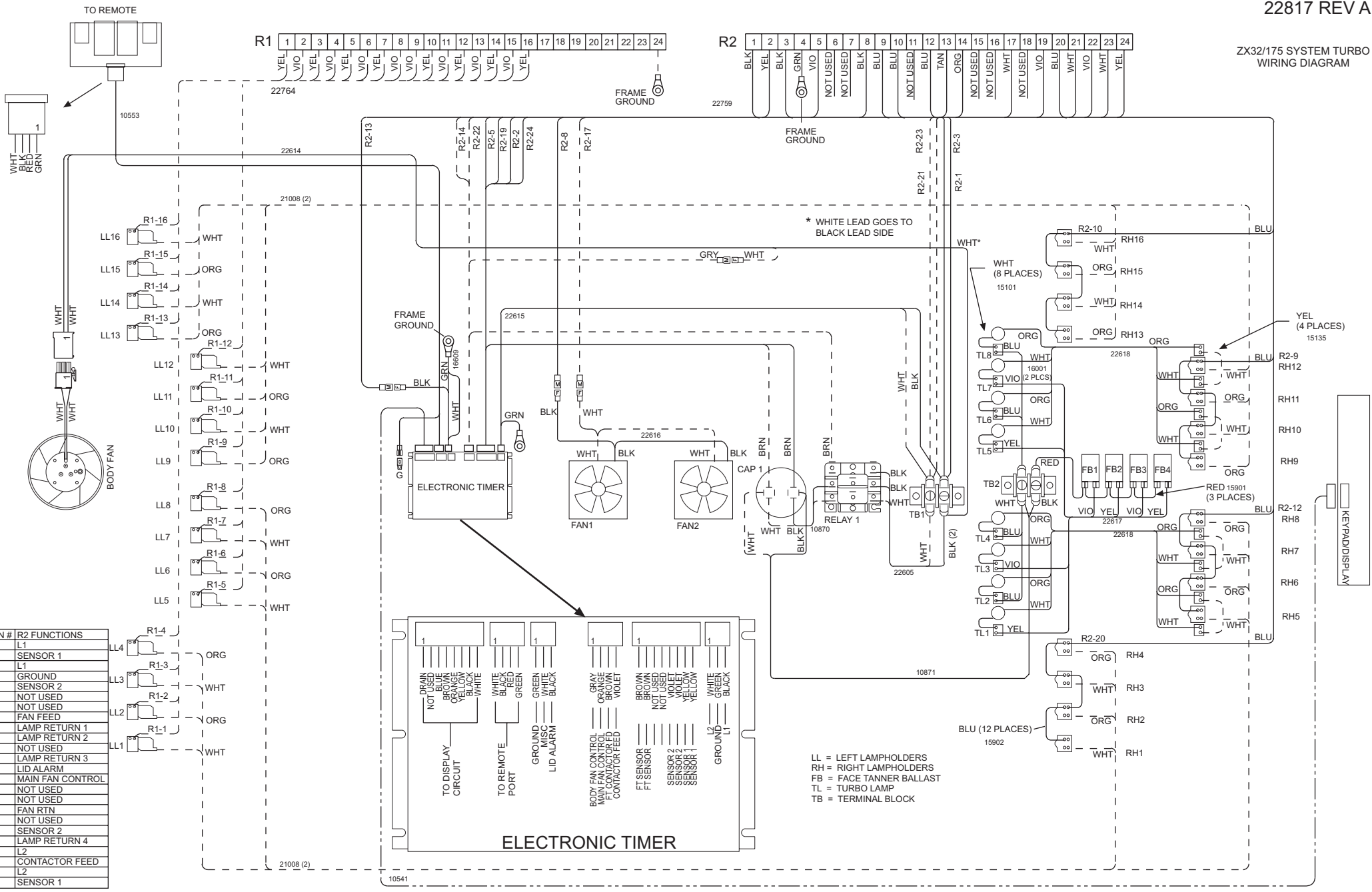

PIN #	R2 FUNCTIONS
1	L1
2	SENSOR 1
3	L1
4	GROUND
5	SENSOR 2
6	NOT USED
7	NOT USED
8	FAN FEED
9	LAMP RETURN 1
10	LAMP RETURN 2
11	NOT USED
12	LAMP RETURN 3
13	LID ALARM
14	MAIN FAN CONTROL
15	NOT USED
16	NOT USED
17	FAN RTN
18	NOT USED
19	SENSOR 2
20	LAMP RETURN 4
21	L2
22	CONTACTOR FEED
23	L2
24	SENSOR 1

LL = LEFT LAMP HOLDERS
RH = RIGHT LAMP HOLDERS
FB = FACE TANNER BALLAST
TL = TURBO LAMP
TB = TERMINAL BLOCK

16 LAMP TRAY, BENCH SIDE
WIRING DIAGRAM

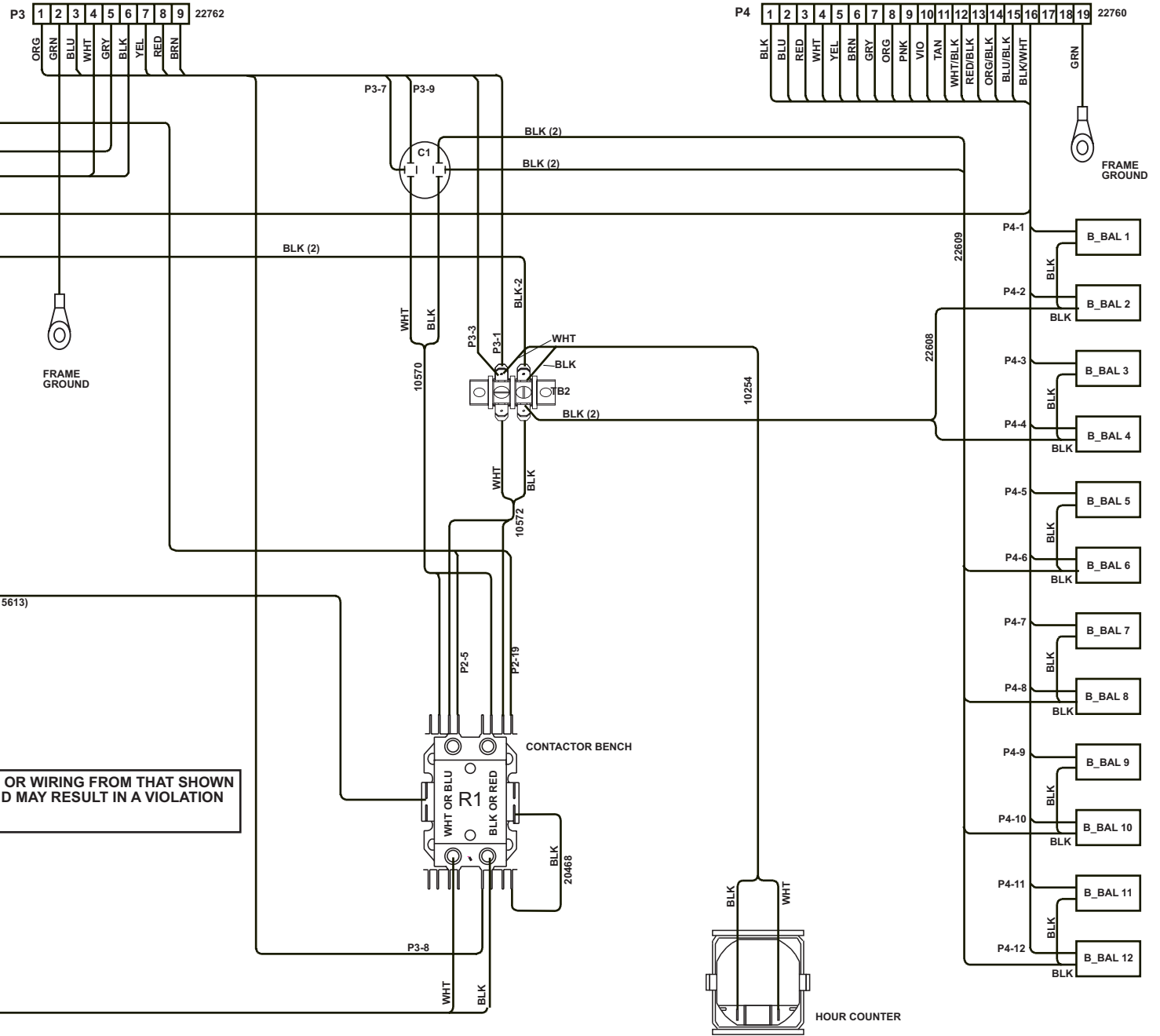

WARNING : ALTERING THE DESIGN, TIMER SYSTEM, OR WIRING FROM THAT SHOWN HEREIN, WILL VOID THE WARRANTY, AND MAY RESULT IN A VIOLATION OF FEDERAL LAW.

B_BAL = BALLAST FOR BENCH

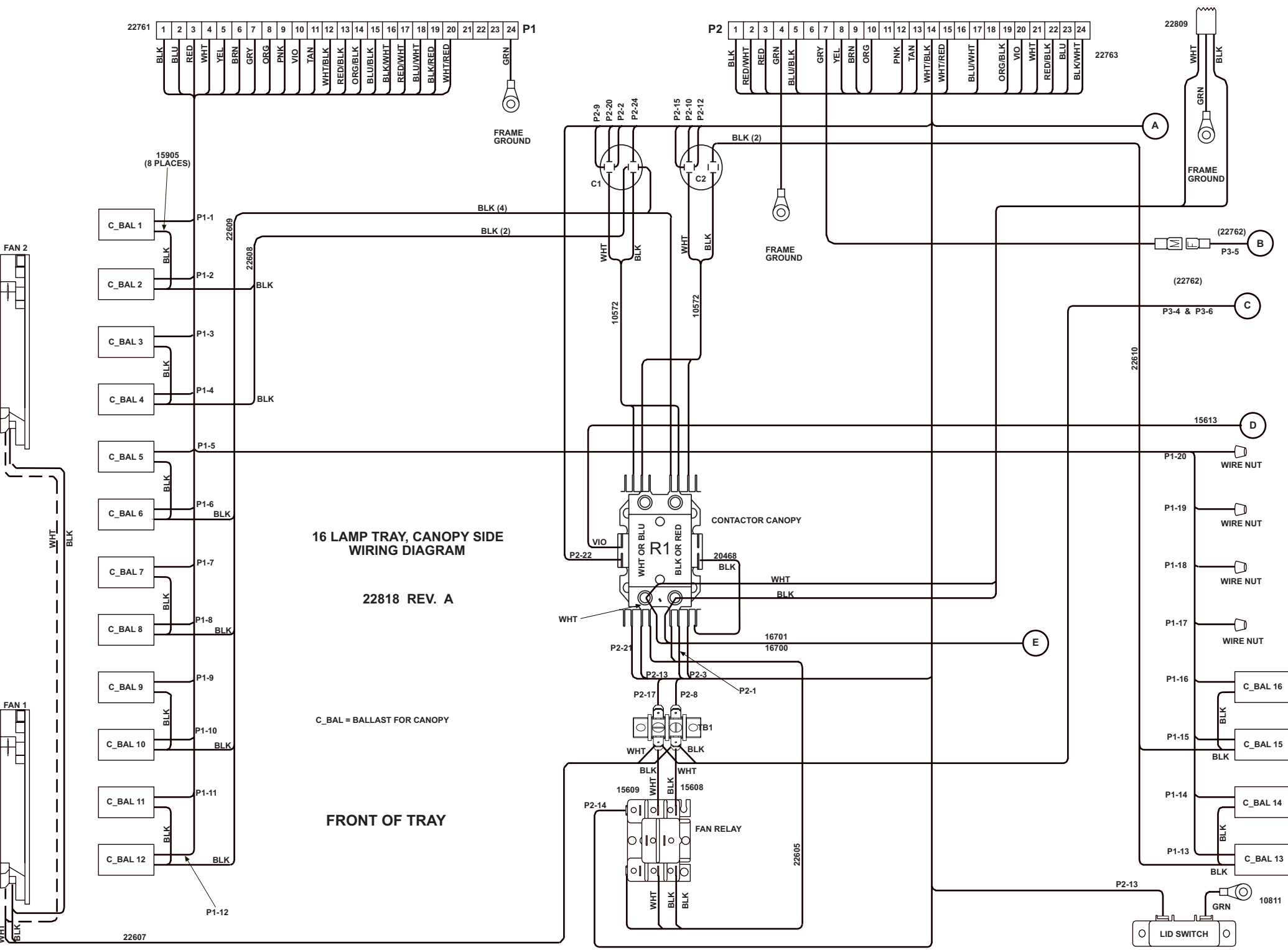

16 LAMP TRAY, CANOPY SIDE WIRING DIAGRAM

22818 REV. A

C_BAL = BALLAST FOR CANOPY

FRONT OF TRAY

22761

1	2	3	4	5	6	7	8	9	10	11	12	13	14	15	16	17	18	19	20	21	22	23	24
BLK	BLU	RED	WHT	YEL	BRN	GRY	ORG	PNK	VIO	TAN	WHT/BLK	RED/BLK	ORG/BLK	BLU/BLK	BLK/WHT	RED/WHT	BLU/WHT	BLK/RED	WHT/RED				

22763

1	2	3	4	5	6	7	8	9	10	11	12	13	14	15	16	17	18	19	20	21	22	23	24
BLK	RED/WHT	RED	GRN	BLU/BLK	GRY	YEL	BRN	ORG	PNK	TAN	WHT/BLK	WHT/RED	BLU/WHT	ORG/BLK	VIO	WHT	RED/BLK	BLU	BLK/WHT				

