

SUNSTAR SUPER 40-3F BENCH
WIRING DIAGRAM

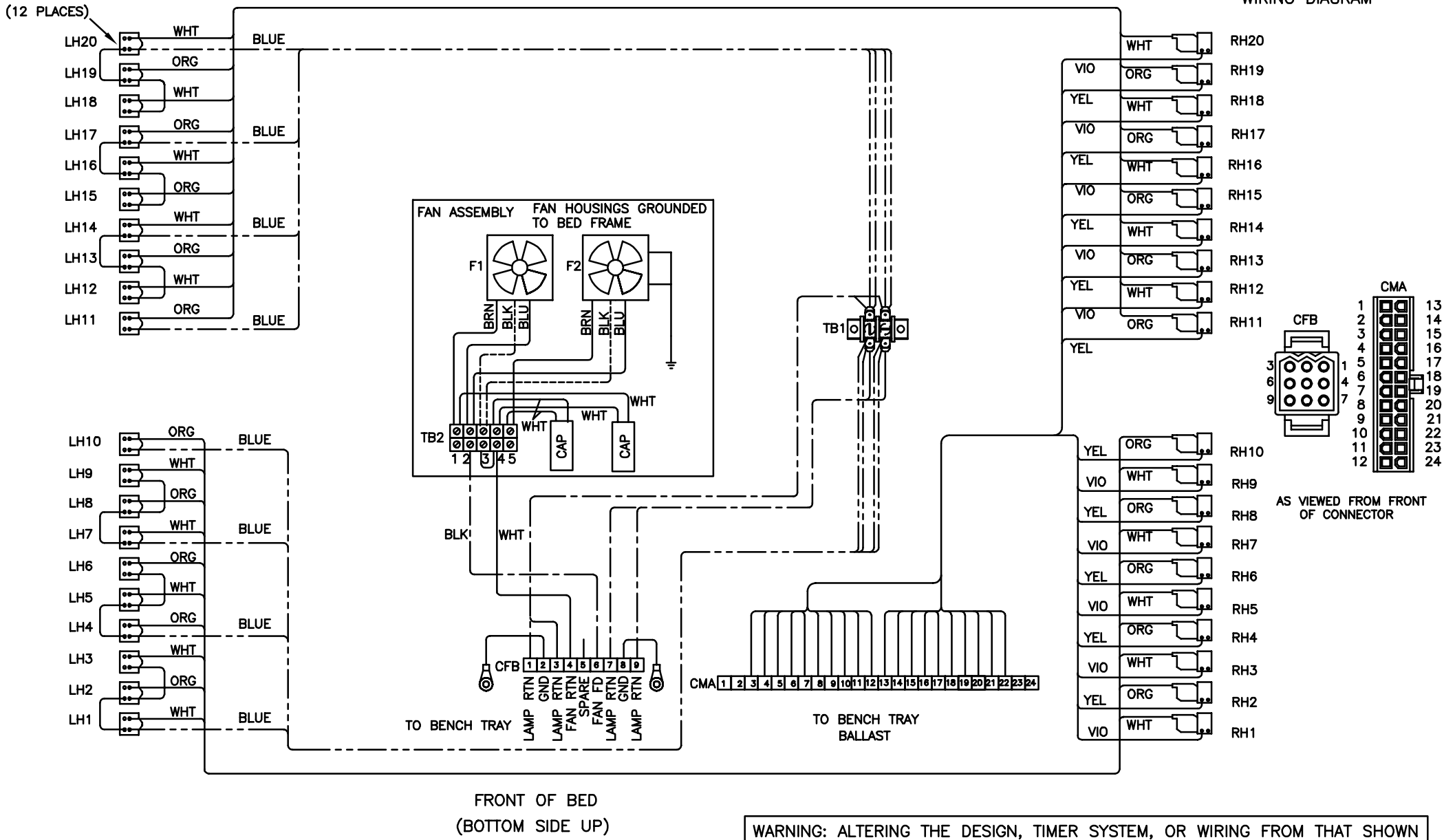

AS VIEWED FROM FRONT OF CONNECTOR

WARNING: ALTERING THE DESIGN, TIMER SYSTEM, OR WIRING FROM THAT SHOWN HEREIN, WILL VOID THE WARRANTY, AND MAY RESULT IN A VIOLATION OF FEDERAL LAW.

NOTE: 1.WIRE COLORS MAY NOT BE EXACTLY AS SHOWN.

SUNSTAR 40-3F CANOPY WIRING DIAGRAM

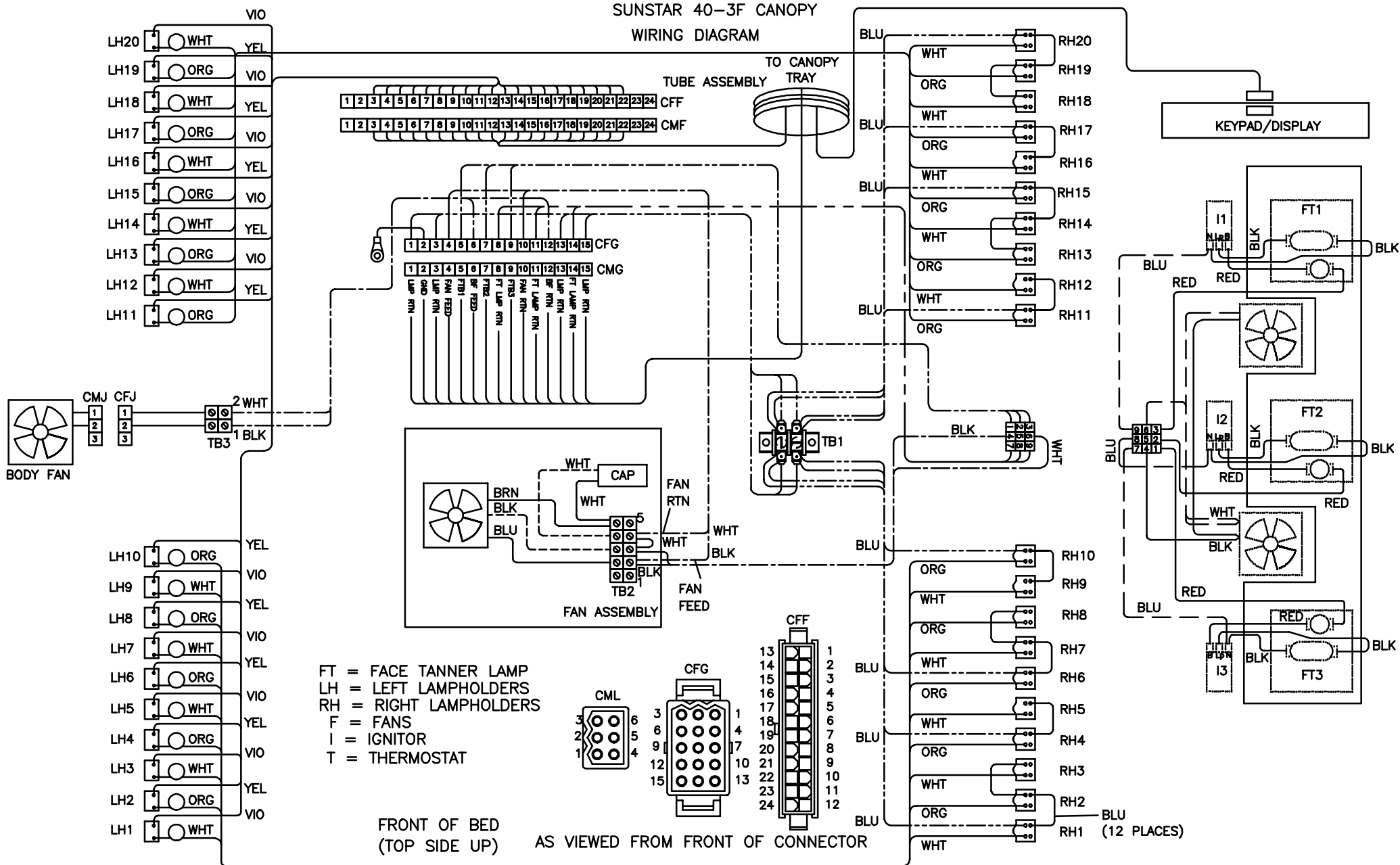

NOTE: 1. WIRE COLORS MAY NOT BE EXACTLY AS SHOWN.

SUNSTAR SUPER
ZX40 3F BENCH TRAY
WIRING DIAGRAM

NOTE: 1.WIRE COLORS MAY NOT BE
EXACTLY AS SHOWN.

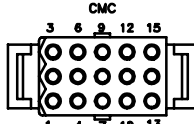

AS VIEWED FROM FRONT OF CONNECTOR.

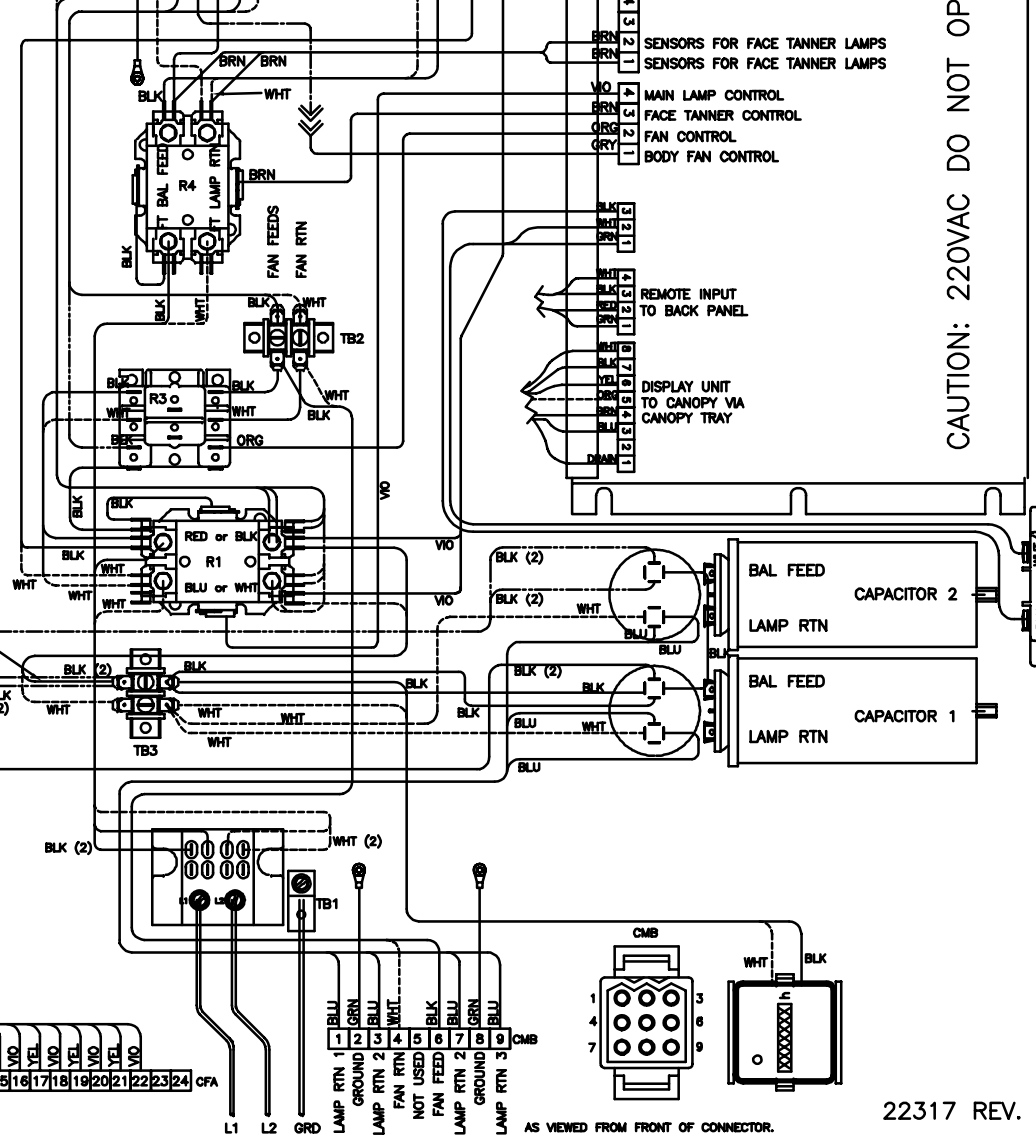
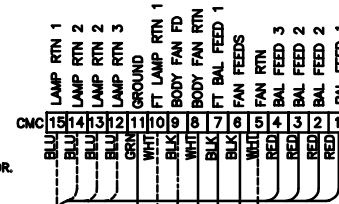

CAUTION: 220VAC DO NOT OPEN TIMER

PROXIMITY SWITCH

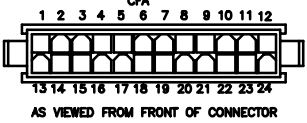
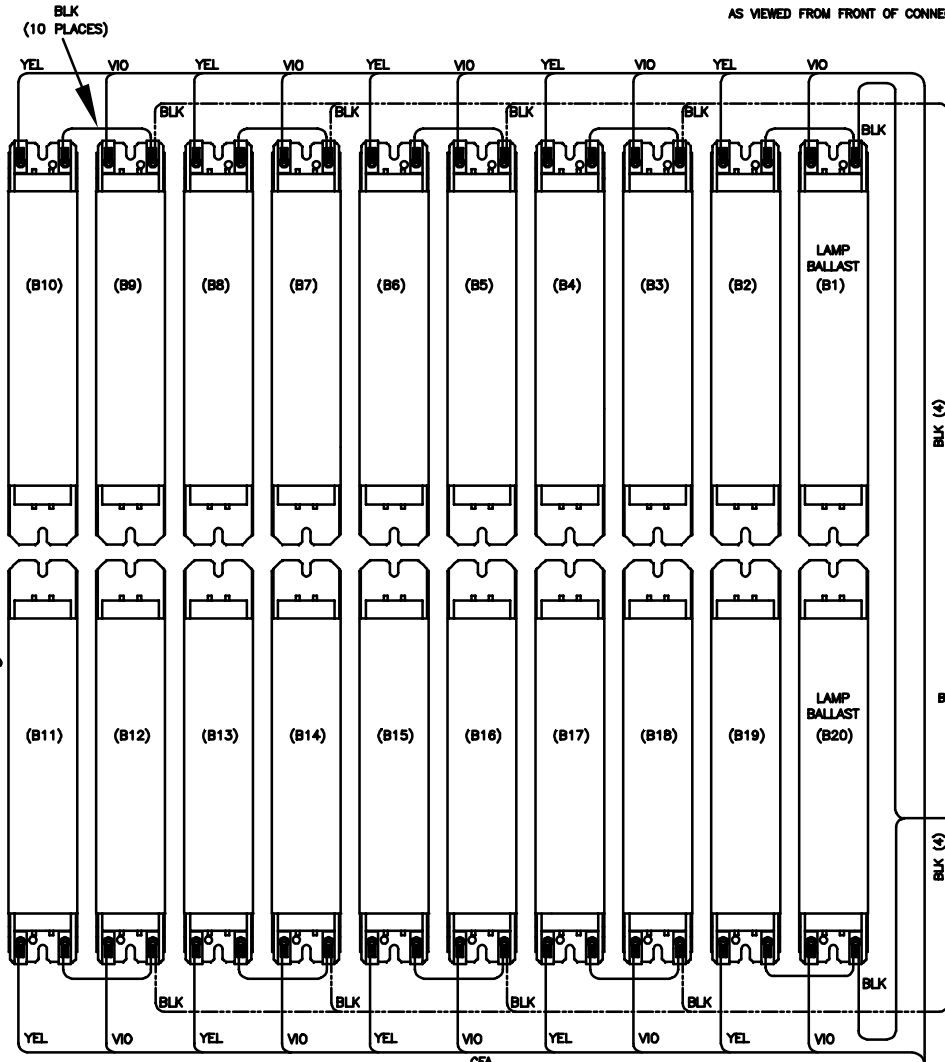

AS VIEWED FROM FRONT OF CONNECTOR

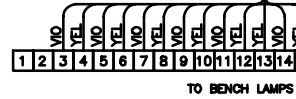

TO BENCH LAMPS

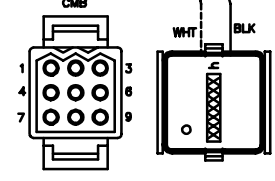

AS VIEWED FROM FRONT OF CONNECTOR.

SUNSTAR SUPER
ZX40 3F CANOPY TRAY
WIRING DIAGRAM

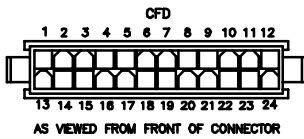

NOTE: 1. WIRE COLORS MAY NOT BE EXACTLY AS SHOWN.

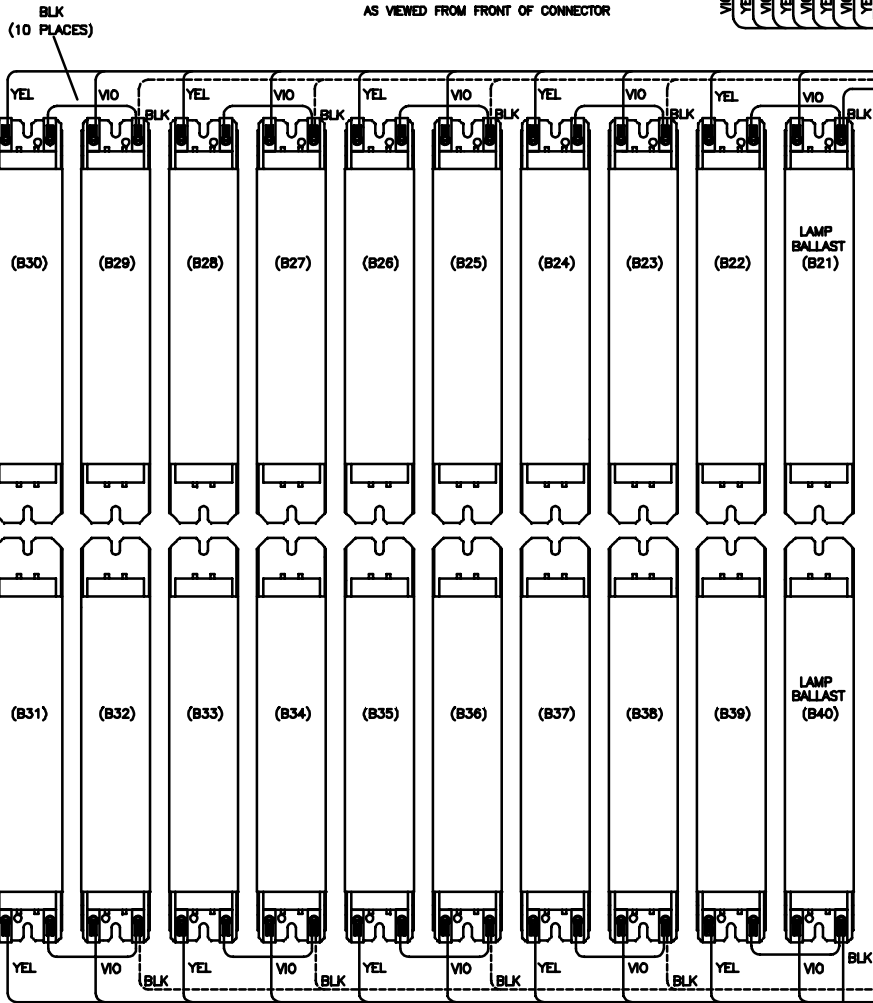

WARNING: ALTERING THE DESIGN, TIMER SYSTEM, OR WIRING FROM THAT SHOWN HEREIN, WILL VOID THE WARRANTY, AND MAY RESULT IN A VIOLATION OF FEDERAL LAW.

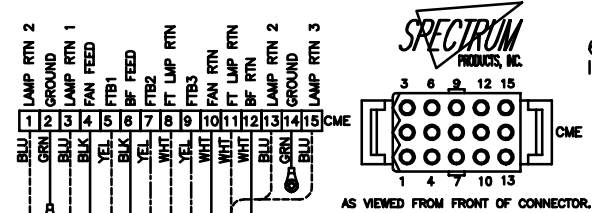

6220 CHURCHMAN BYPASS
INDIANAPOLIS, IN 46203

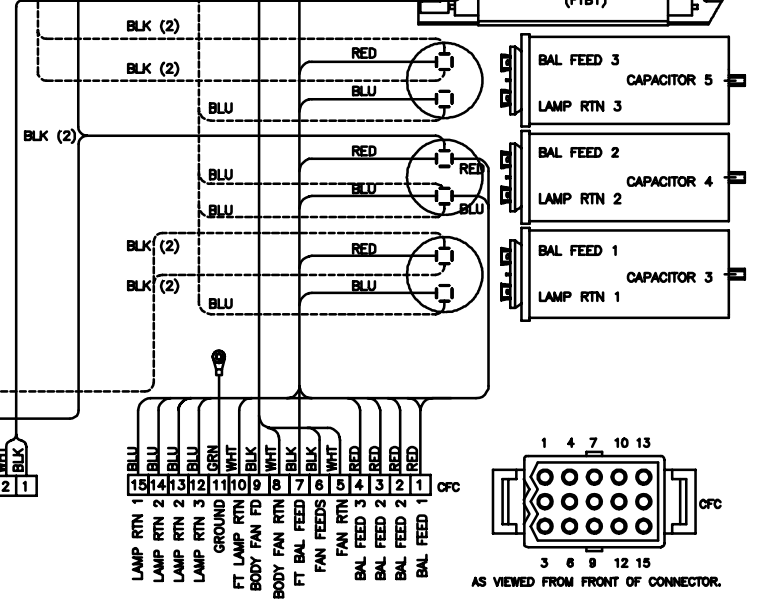
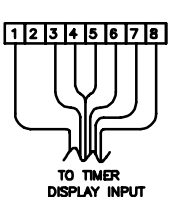
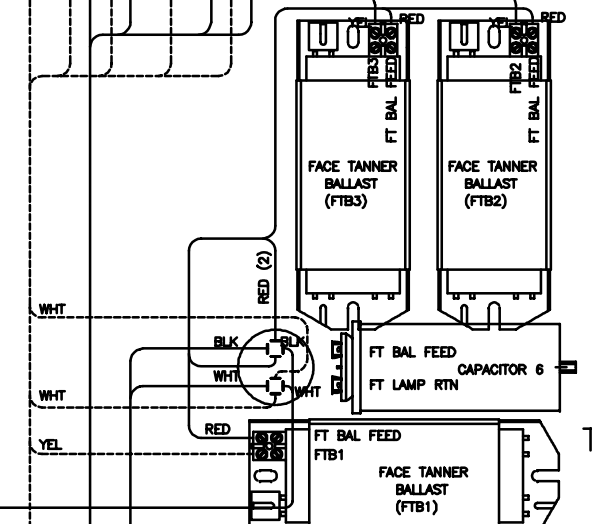

TRAY FRONT

