

SUNSTAR SUPER 44-3F BENCH
WIRING DIAGRAM

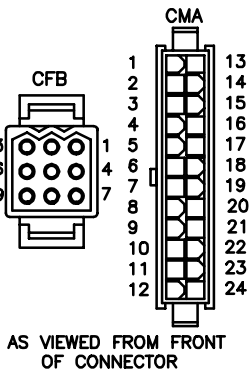
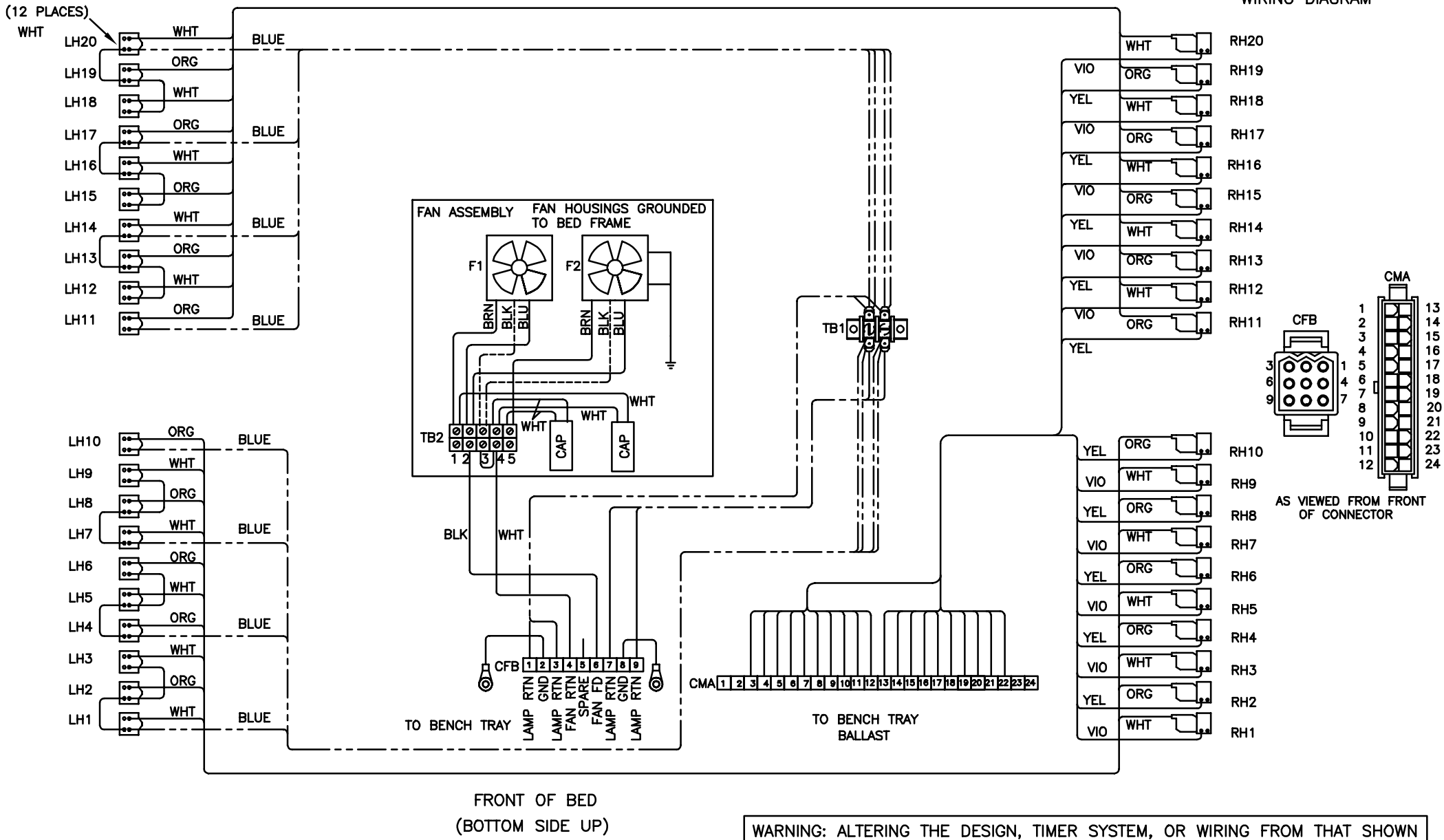

NOTE: 1. WIRE COLORS MAY NOT BE EXACTLY AS SHOWN.

WARNING: ALTERING THE DESIGN, TIMER SYSTEM, OR WIRING FROM THAT SHOWN HEREIN, WILL VOID THE WARRANTY, AND MAY RESULT IN A VIOLATION OF FEDERAL LAW.

SUNSTAR SUPER
ZX44 3F BENCH TRAY
WIRING DIAGRAM

NOTE: 1. WIRE COLORS MAY NOT BE
EXACTLY AS SHOWN.

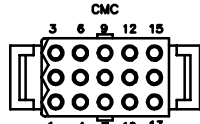

AS VIEWED FROM FRONT OF CONNECTOR.

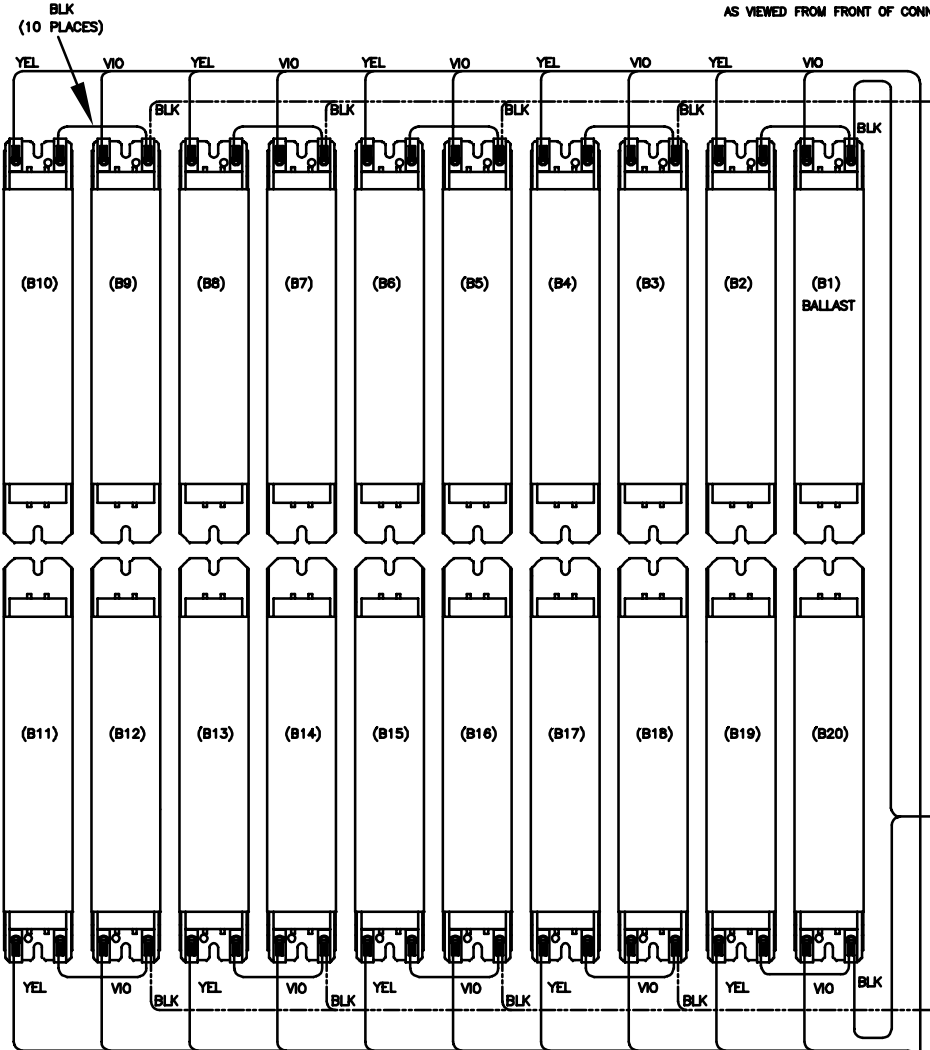
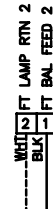
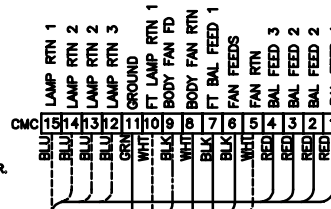

BLK
(10 PLACES)

(B10) (B9) (B8) (B7) (B6) (B5) (B4) (B3) (B2) (B1) BALLAST

(B11) (B12) (B13) (B14) (B15) (B16) (B17) (B18) (B19) (B20)

BACK PANEL
REMOTE

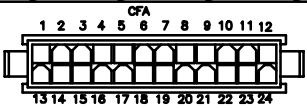

AS VIEWED FROM FRONT OF CONNECTOR

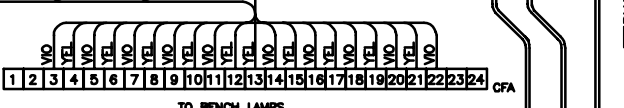

TO BENCH LAMPS



AS VIEWED FROM FRONT OF CONNECTOR.

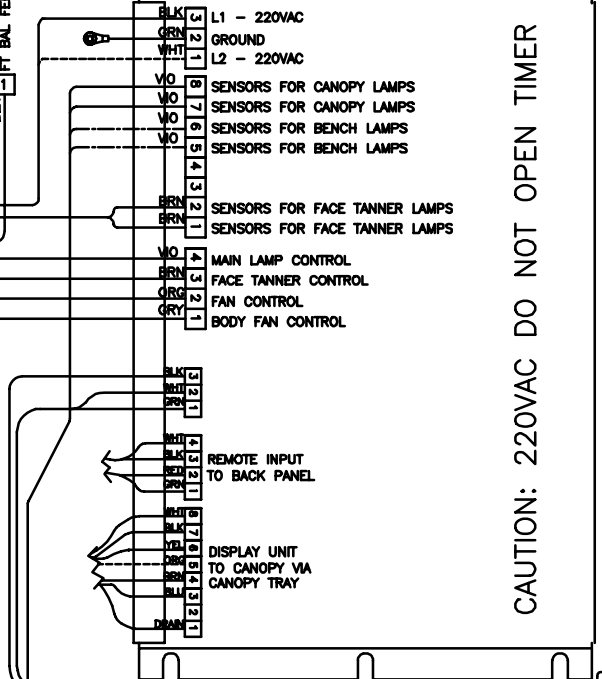

CAUTION: 220VAC DO NOT OPEN TIMER

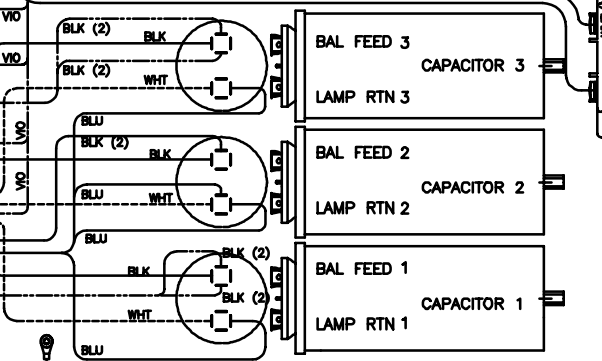

PROXIMITY SWITCH

SUNSTAR SUPER
ZX44 3F CANOPY TRAY
WIRING DIAGRAM

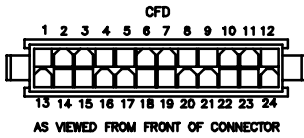

NOTE: 1. WIRE COLORS MAY NOT BE EXACTLY AS SHOWN.

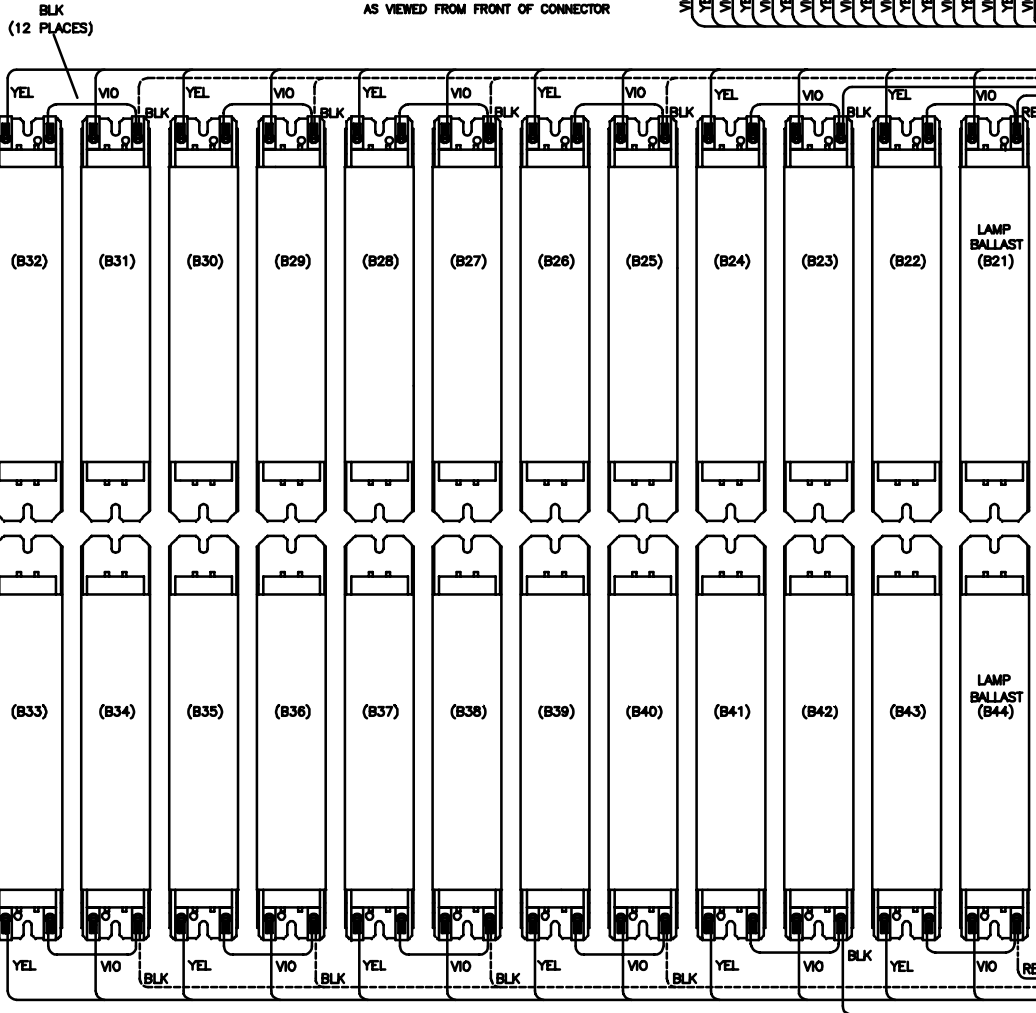

WARNING: ALTERING THE DESIGN, TIMER SYSTEM, OR WIRING FROM THAT SHOWN HEREIN, WILL VOID THE WARRANTY, AND MAY RESULT IN A VIOLATION OF FEDERAL LAW.

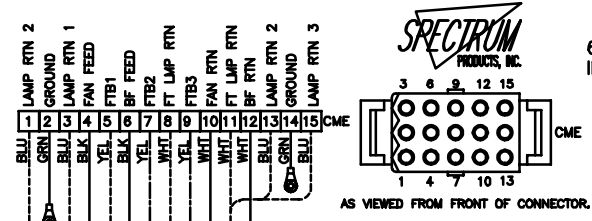

6220 CHURCHMAN BYPASS
INDIANAPOLIS, IN 46203

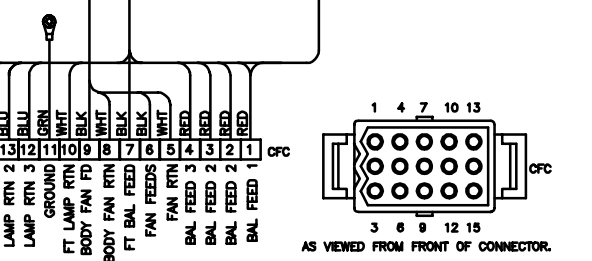
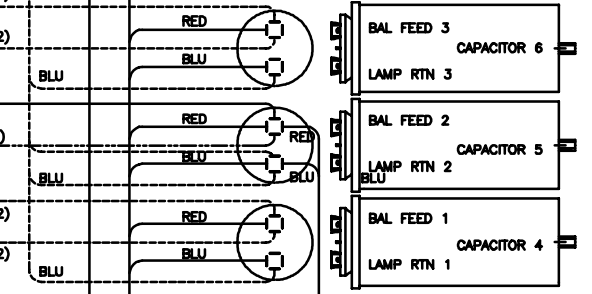
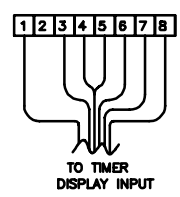
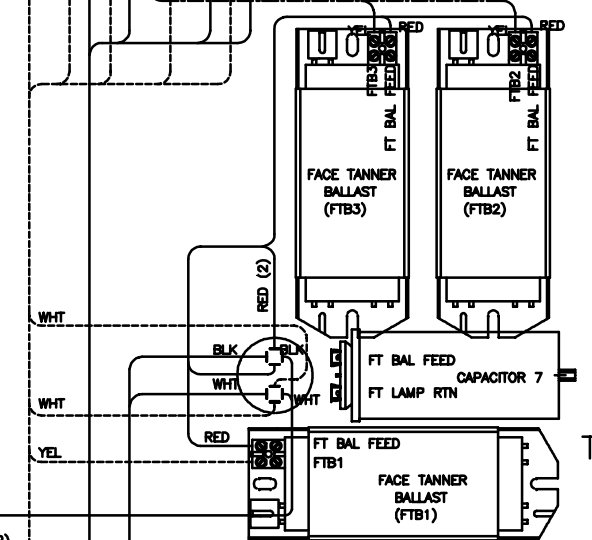

TRAY FRONT